

## Protector® Series

### PROTECTOR® SERIES Standby Generators Liquid-Cooled Gas Engine

#### INCLUDES:

- Two Line LCD Multilingual Digital Evolution™ Controller (English/Spanish/French/Portuguese) with external viewing window for easy indication of generator status and breaker position.
- True Power™ Electrical Technology
- Isochronous Electronic Governor
- Sound Attenuated Enclosure
- Closed Coolant Recovery System
- Smart Battery Charger
- UV/Ozone Resistant Hoses
- ±1% Voltage Regulation
- Natural Gas or LP Operation
- 5 Year Limited Warranty
- UL 2200 Listed

#### Standby Power Rating

- Model RG025 (Steel - Bisque or Aluminum - Gray) - 25 kW 60 Hz
- Model RG030 (Steel - Bisque or Aluminum - Gray) - 30 kW 60 Hz
- Model RG036 (Steel - Bisque or Aluminum - Gray) - 36 kW 60 Hz
- Model RG045 (Steel - Bisque or Aluminum - Gray) - 45 kW 60 Hz
- Model RG060 (Steel - Bisque or Aluminum - Gray) - 60 kW 60 Hz



QUIET-TEST™

\*Note: 25-45 kW units are field convertible between natural gas or LP. 60 kW units are built per fuel requirement and are not convertible.

Meets EPA Emission Regulations  
25, 30 & 45 kW CA/MA emissions compliant  
36 & 60 kW not for sale in CA/MA

## FEATURES

- **INNOVATIVE DESIGN & PROTOTYPE TESTING** are key components of GENERAC'S success in "IMPROVING POWER BY DESIGN." But it doesn't stop there. Total commitment to component testing, reliability testing, environmental testing, destruction and life testing, plus testing to applicable CSA, NEMA, EGSA, and other standards, allows you to choose GENERAC POWER SYSTEMS with the confidence that these systems will provide superior performance.
- **TEST CRITERIA:**
  - ✓ **PROTOTYPE TESTED**
  - ✓ **SYSTEM TORSIONAL TESTED**
  - ✓ **NEMA MG1-22 EVALUATION**
  - ✓ **MOTOR STARTING ABILITY**
- **SOLID-STATE, FREQUENCY COMPENSATED VOLTAGE REGULATION.** This state-of-the-art power maximizing regulation system is standard on all Generac models. It provides optimized FAST RESPONSE to changing load conditions and MAXIMUM MOTOR STARTING CAPABILITY by electronically torque-matching the surge loads to the engine. Digital voltage regulation at ±1%.
- **SINGLE SOURCE SERVICE RESPONSE** from Generac's extensive dealer network provides parts and service know-how for the entire unit, from the engine to the smallest electronic component.
- **GENERAC TRANSFER SWITCHES.** Long life and reliability are synonymous with GENERAC POWER SYSTEMS. One reason for this confidence is that the GENERAC product line includes its own transfer systems and controls for total system compatibility.

25 • 30 • 36 • 45 • 60 kW

**GENERATOR SPECIFICATIONS**

Type	Synchronous
Rotor Insulation Class	H
Stator Insulation Class	H
Telephone Interference Factor (TIF)	<50
Alternator Output Leads 1-Phase	4 wire
Alternator Output Leads 3-Phase	6 wire
Bearings	Sealed Ball
Coupling	Flexible Disc
Excitation System	Direct

**VOLTAGE REGULATION**

Type	Electronic
Sensing	Single Phase
Regulation	± 1%

**GOVERNOR SPECIFICATIONS**

Type	Electronic
Frequency Regulation	Isochronous
Steady State Regulation	± 0.25%

**ELECTRICAL SYSTEM**

Battery Charge Alternator	12 Volt 15 Amp - 25 & 30 kW 12 Volt 30 Amp - 36, 45 & 60 kW
Static Battery Charger	2 Amp
Recommended Battery	Group 26, 525CCA
System Voltage	12 Volts

**GENERATOR FEATURES**

Revolving field heavy duty generator Directly connected to the engine Operating temperature rise 120 °C above a 40 °C ambient Class H insulation is rated at 150 °C rise at 25 °C ambient All models fully prototyped tested
--

**ENCLOSURE FEATURES**

Steel weather protective enclosure with aluminum roof (all models) or aluminum weather protective enclosure (available on 60 kW only)	Ensures protection against mother nature. Electrostatically applied textured epoxy paint for added durability.
Enclosed critical grade muffler	Quiet, critical grade muffler is mounted inside the unit to prevent injuries.
Small, compact, attractive	Makes for an easy, eye appealing installation.
SAE	Sound attenuated enclosure ensures quiet operation.

**ENGINE SPECIFICATIONS: 25 & 30 kW**

Make	Generac
Model	In-line
Cylinders	4
Displacement (Liters)	1.5
Bore (in/mm)	3.05/77.4
Stroke (in/mm)	3.13/79.5
Compression Ratio	11:1
Intake Air System	Naturally Aspirated
Lifter Type	Hydraulic

**ENGINE SPECIFICATIONS: 36, 45 & 60 kW**

Make	Generac
Model	In-line
Cylinders	4
Displacement (Liters)	2.4
Bore (in/mm)	3.41/86.5
Stroke (in/mm)	3.94/100
Compression Ratio	9.5:1
Intake Air System	Naturally Aspirated (36 & 45 kW) or Turbocharged/Aftercooled (60 kW)
Lifter Type	Hydraulic

**ENGINE LUBRICATION SYSTEM**

Oil Pump Type	Gear
Oil Filter Type	Full flow spin-on cartridge
Crankcase Capacity (qt/l)	4/3.8 - 25, 30, 36 & 45 kW 5.25/4.96 - 60 kW

**ENGINE COOLING SYSTEM**

Type	Closed
Water Pump	Belt driven
Fan Speed (rpm)	2484 - 25 & 30 kW 1865 - 36 & 45 kW 2100 - 60 kW
Fan Diameter (in/mm)	17.7/449.6 (25 & 30 kW) or 22/558.8 (36, 45 & 60 kW)
Fan Mode	Pusher (25 & 30 kW) or Puller (36, 45 & 60 kW)

**FUEL SYSTEM**

Fuel Type	Natural gas, propane vapor
Carburetor	Down Draft
Secondary Fuel Regulator	Standard
Fuel Shut Off Solenoid	Standard
Operating Fuel Pressure	5-14" water column/9-26 mm HG

(All ratings in accordance with BS5514, ISO3046, ISO8528, SAE J1349 and DIN6271)

## 25 • 30 • 36 • 45 • 60 kW

## operating data

### GENERATOR OUTPUT VOLTAGE/kW - 60 Hz

		kW LPG	Amp LPG	kW Nat. Gas	Amp Nat. Gas	CB Size (Both)
RG025	120/240 V, 1Ø, 1.0 pf	25	104	25	104	125
	120/208 V, 3Ø, 0.8 pf	25	87	25	87	100
	120/240 V, 3Ø, 0.8 pf	25	75	25	75	90
RG030	120/240 V, 1Ø, 1.0 pf	30	125	30	125	150
	120/208 V, 3Ø, 0.8 pf	30	104	30	104	125
	120/240 V, 3Ø, 0.8 pf	30	90	30	90	100
RG036	120/240 V, 1Ø, 1.0 pf	36	150	36	150	175
	120/208 V, 3Ø, 0.8 pf	36	125	36	125	150
	120/240 V, 3Ø, 0.8 pf	36	108	36	108	125
	277/480 V, 3Ø, 0.8 pf	36	54	36	54	60
RG045	120/240 V, 1Ø, 1.0 pf	45	188	45	188	200
	120/208 V, 3Ø, 0.8 pf	45	156	45	156	175
	120/240 V, 3Ø, 0.8 pf	45	135	45	135	150
	277/480 V, 3Ø, 0.8 pf	45	68	45	68	80
RG060	120/240 V, 1Ø, 1.0 pf	60	250	60	250	300
	120/208 V, 3Ø, 0.8 pf	60	208	60	208	250
	120/240 V, 3Ø, 0.8 pf	60	180	60	180	200
	277/480 V, 3Ø, 0.8 pf	60	90	60	90	100

### SURGE CAPACITY IN AMPS

		Voltage Dip @ < .4 pf	
		15%	30%
RG025	120/240 V, 1Ø	65	170
	120/208 V, 3Ø	80	130
	120/240 V, 3Ø	69	112
RG030	120/240 V, 1Ø	75	180
	120/208 V, 3Ø	96	155
	120/240 V, 3Ø	83	134
RG036	120/240 V, 1Ø	105	240
	120/208 V, 3Ø	44	130
	120/240 V, 3Ø	38	115
	277/480 V, 3Ø	20	60
RG045	120/240 V, 1Ø	105	240
	120/208 V, 3Ø	44	130
	120/240 V, 3Ø	38	115
	277/480 V, 3Ø	20	60
RG060	120/240 V, 1Ø	140	320
	120/208 V, 3Ø	70	210
	120/240 V, 3Ø	61	182
	277/480 V, 3Ø	30	91

### ENGINE FUEL CONSUMPTION

		Natural Gas		Propane		
		(ft³/hr)	(m³/hr)	(gal/hr)	(l/hr)	(ft³/hr)
RG025	Exercise cycle	60	1.7	0.7	2.5	24
	25% of rated load	220	6.3	2.9	9.1	88
	50% of rated load	297	8.4	3.3	12.3	119
	75% of rated load	362	10.3	4	15	145
	100% of rated load	430	12.2	4.7	17.8	172
RG030	Exercise cycle	60	1.7	0.7	2.5	24
	25% of rated load	240	6.8	2.6	10	96
	50% of rated load	320	9.1	3.5	13.3	128
	75% of rated load	400	11.4	4.4	16.6	160
	100% of rated load	492	14	5.4	20.4	197
RG036	Exercise cycle	65	108	0.7	2.6	25
	25% of rated load	210	6	2.3	8.6	83
	50% of rated load	380	10.8	4.2	15.7	151
	75% of rated load	545	15.5	5.9	22.4	216
	100% of rated load	730	20.7	8	30.1	290
RG045	Exercise cycle	65	1.8	0.7	2.6	25
	25% of rated load	210	6	2.3	8.6	83
	50% of rated load	380	10.8	4.2	15.7	151
	75% of rated load	545	15.5	5.9	22.4	216
	100% of rated load	730	20.7	8	30.1	290
RG060	Exercise cycle	123	3.5	1.34	5.1	49.3
	25% of rated load	267	7.6	2.7	10.5	101
	50% of rated load	483	13.7	5	19	183
	75% of rated load	672	19.1	7	26.5	255
	100% of rated load	862	24.5	9	33.9	327

Note: **Fuel pipe must be sized for full load.**

For Btu content, multiply ft³/hr x 2520 (LP) or ft³/hr x 1000 (NG)

For megajoule content, multiply m³/hr x 93.15 (LP) or m³/hr x 37.26 (NG)

Refer to "Emissions Data Sheets" for maximum fuel flow for EPA and SCAQMD permitting purposes.

STANDBY RATING: Standby ratings apply to installations served by a reliable utility source. The standby rating is applicable to varying loads for the duration of a power outage. There is no overload capability for this rating. Ratings are in accordance with ISO-3046-1. Design and specifications are subject to change without notice.

## 25 • 30 • 36 • 45 • 60 kW

## operating data

### ENGINE COOLING

	25 kW	30 kW	36 kW	45 kW	60 kW
Air flow (inlet air including alternator and combustion air in cfm/cmm)	2490/70.5	2490/70.5	2725/77.2	2725/77.2	3280/92.9
System coolant capacity (gal/liters)	2/7.6	2/7.6	2.5/9.5	2.5/9.5	2.5/9.5
Heat rejection to coolant (BTU per hr/MJ per hr)	112,000/118.2	135,000/142.4	193,000/203.6	193,000/203.6	270,000/284.9
Maximum operation air temperature on radiator (°C/°F)	60/150				
Maximum ambient temperature (°C/°F)	50/140				

### COMBUSTION REQUIREMENTS

Flow at rated power (cfm/cmm)	62/1.8	72/2	144/4.1	144/4.1	180/5.1
-------------------------------	--------	------	---------	---------	---------

### SOUND EMISSIONS

Sound output in dB(A) at 23 ft (7 m) with generator in exercise mode*	59	59	61	61	65
Sound output in dB(A) at 23 ft (7 m) with generator operating at normal load*	72	73	70	73	72

\*Sound levels are taken from the front of the generator. Sound levels taken from other sides of the generator may be higher depending on installation parameters.

### EXHAUST

Exhaust flow at rated output (cfm/cmm)	203/5.7	237/6.7	300/8.5	420/11.9	494/14
Exhaust temperature at muffler outlet (°C/°F)	593/1100	610/1130	579/1075	593/1100	566/1050

### ENGINE PARAMETERS

Rated Synchronous rpm	3600
-----------------------	------

### POWER ADJUSTMENT FOR AMBIENT CONDITIONS

Temperature Deration .....3% for every 10 °C above 25 °C or 1.65% for every 10 °F above 77 °F  
 Altitude Deration (25, 30, 36 & 45 kW) .....1% for every 100 m above 183 m or 3% for every 1000 ft above 600 ft  
 Altitude Deration (60 kW) .....1% for every 100 m above 915 m or 3% for every 1000 ft above 3000 ft

### CONTROLLER FEATURES

2-Line Plain Text LCD Display .....Simple user interface for ease of operation.  
 Mode Switch: Auto .....Automatic Start on Utility failure. 7 day exerciser  
                   Off .....Stops unit. Power is removed. Control and charger still operate.  
                   Manual .....Start with starter control, unit stays on. If utility fails, transfer to load takes place.  
 Programmable start delay between 10-30 seconds .....Standard  
 Engine Start Sequence .....Cyclic cranking: 16 sec on, 7 rest (90 sec maximum duration)  
 Engine Warm-up .....5 sec  
 Engine Cool-Down .....1 min  
 Starter Lock-out .....Starter cannot re-engage until 5 sec after engine has stopped.  
 Smart Battery Charger .....Standard  
 Automatic Voltage Regulation with Over and Under Voltage Protection .....Standard  
 Automatic Low Oil Pressure Shutdown .....Standard  
 Overspeed Shutdown .....Standard, 72 Hz  
 High Temperature Shutdown .....Standard  
 Overcrank Protection .....Standard  
 Safety Fused .....Standard  
 Failure to Transfer Protection .....Standard  
 Low Battery Protection .....Standard  
 50 Event Run Log .....Standard  
 Future Set Capable Exerciser .....Standard  
 Incorrect Wiring Protection .....Standard  
 Internal Fault Protection .....Standard  
 Common External Fault Capability .....Standard  
 Governor Failure Protection .....Standard

Model #	Product	Description
006463-3	Mobile Link™	Generac's Mobile Link allows you to check the status of your generator from anywhere that you have access to an Internet connection from a PC or with any smart device. You will even be notified when a change in the generator's status occurs via e-mail or text message. Note: Harness Adapter Kit required.
006478-0	Harness Adapter Kit	The Harness Adapter Kit is required to make liquid-cooled units compatible with Mobile Link™.
006175-0 - 25 & 30 kW 005630-1 - 36, 45 & 60 kW	Cold Weather Kit	If the temperature regularly falls below 32 °F (0 °C), install a cold weather kit to maintain optimal battery temperature. Kit consists of battery warmer with thermostat built into the wrap.
006174-0 - 25 & 30 kW 005616-0 - 36, 45 & 60 kW	Extreme Cold Weather Kit	Recommended where the temperature regularly falls below 32 °F (0 °C) for extended periods of time. For liquid cooled units only.
005651-0	Base Plug Kit	Add base plugs to the base of the generator to keep out debris.
005703-0 - Bisque 005704-0 - Gray	Paint Kit*	If the generator enclosure is scratched or damaged, it is important to touch-up the paint to protect from future corrosion. The paint kit includes the necessary paint to properly maintain or touch-up a generator enclosure.
006176-0 - 25 & 30 kW 006172-0 - 36 & 45 kW 006171-0 - 60 kW	Scheduled Maintenance Kit	The Liquid-Cooled Scheduled Maintenance Kits offer all the hardware necessary to perform complete maintenance on Generac liquid-cooled generators.
005928-0	Wireless Remote	Completely wireless and battery powered, Generac's wireless remote monitor provides you with instant status information without ever leaving the house.
006665-0	Wireless Remote Extension Harness	Recommended for use with the Wireless Remote on units up to 60 kW, required for use on units 70 kW or greater.
006710-0	Smart Management Module (50 Amps)	Smart Management Modules are used in conjunction with the Automatic Transfer Switch to increase its power management capabilities. It provides additional power management flexibility not found in any other power management system.
006510-0	E-Stop	E-stop allows for immediate fuel shutoff and generator shutdown in the event of an emergency.

\* Note: Bisque kits are used in conjunction with steel enclosures. Gray kits are used in conjunction with aluminum enclosures.

25 & 30 kW

Drawing #0K8420-A (1 of 2)

SERVICE ITEM	1.5L
OIL FILL CAP	EITHER DOOR
OIL DIP STICK	RIGHT DOOR
OIL FILTER	RIGHT DOOR
OIL DRAIN HOSE	RIGHT DOOR
RADIATOR DRAIN HOSE	RIGHT DOOR
AIR CLEANER ELEMENT	RIGHT DOOR
SPARK PLUGS	SEE NOTE 12
MUFFLER	EITHER DOOR
FAN BELT	EITHER DOOR
BATTERY	RIGHT DOOR

REFERENCE OWNERS MANUAL FOR PERIODIC MAINTENANCE AND REPLACEMENT PART LISTINGS.

- NOTES:
1. MINIMUM RECOMMENDED CONCRETE PAD SIZE: 1092 (43") WIDE X 1887 (74.3") LONG. REFERENCE INSTALLATION GUIDE SUPPLIED WITH UNIT FOR CONCRETE PAD GUIDELINES.
  2. ALLOW SUFFICIENT ROOM ON ALL SIDES OF THE GENERATOR FOR MAINTENANCE AND SERVICE. SEE OWNERS MANUAL FOR MAINTENANCE AND SERVICE AREAS. REFER TO APPLICABLE NFPA 37 AND NFPA 70 STANDARDS AS WELL AS ANY OTHER FEDERAL, STATE, AND LOCAL CODES.
  3. CONTROL PANEL / CIRCUIT BREAKER INFORMATION:
    - SEE SPECIFICATION SHEET OR OWNERS MANUAL.
    - ACCESSIBLE THROUGH CUSTOMER ACCESS ASSEMBLY DOOR ON REAR OF GENERATOR.
    - SEE SPECIFICATION SHEET OR OWNERS MANUAL FOR ACCESS TO REAR DOOR.
    - THE SETUP AREAS AS FOLLOWS:
      - HIGH VOLTAGE CONNECTION INCLUDING AC LOAD LEAD CONDUIT CONNECTION NEUTRAL CONNECTION, BATTERY CHARGER 120 VOLT AC (0.5 AMP MAX) CONNECTION.
      - LOW VOLTAGE CONNECTION INCLUDING TRANSFER SWITCH CONTROL WIRES.
      - CENTER OF GRAVITY AND WEIGHT MAY CHANGE DUE TO UNIT OPTIONS.
  4. REAR ENCLOSURE COVER PANEL:
    - REMOVE COVER PANEL TO ACCESS EXHAUST MUFFLER FOR INSPECTION AND REPAIR.
    - EXHAUST SYSTEM MAXIMUM BACK PRESSURE: 24 INCHES H2O.
  5. REFERENCE OWNERS MANUAL FOR LIFTING WARNINGS.
  6. MOUNTING BOLTS OR STUDS TO MOUNTING SURFACE SHALL BE 5/8-11 GRADE 5 (USE STANDARD SAE TORQUE SPECS).
  7. MUST ALLOW FREE FLOW OF INTAKE AIR, DISCHARGE AIR AND EXHAUST. SEE SPECIFICATION SHEET FOR MOUNTING REQUIREMENTS.
  8. GENERATOR MUST BE INSTALLED SUCH THAT FRESH COOLING AIR IS AVAILABLE AND THAT DISCHARGE AIR FROM RADIATOR IS NOT RECIRCULATED.
  9. EXHAUST MUFFLER ENCLOSED WITHIN GENERATOR ENCLOSURE. REMOVE ENCLOSURE TO ACCESS EXHAUST MUFFLER.

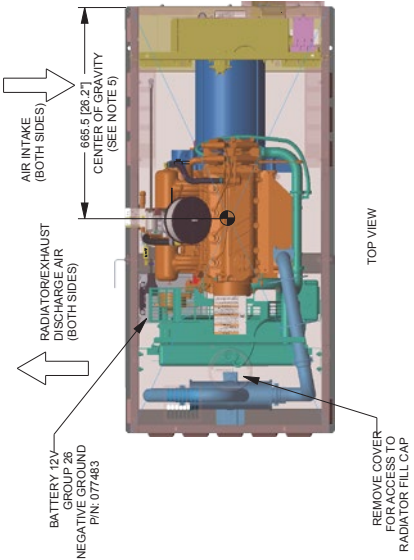
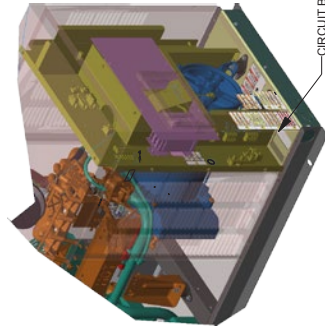

CIRCUIT BREAKER NEUTRAL AND CUSTOMER CONNECTION OPENING

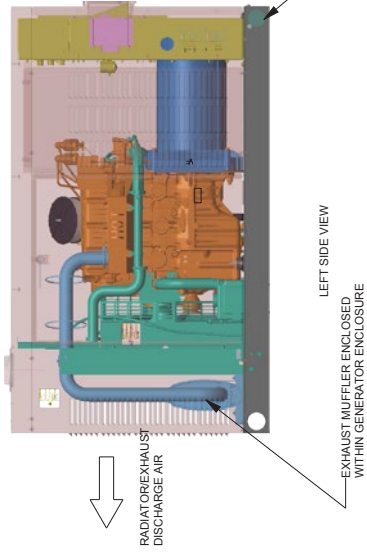
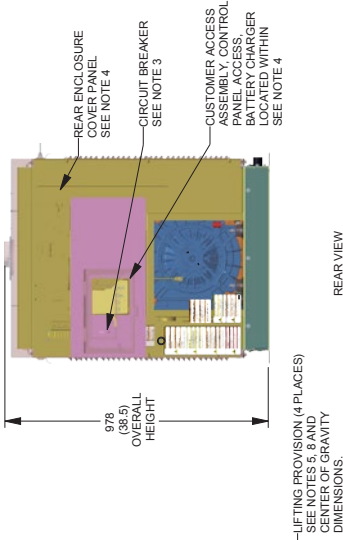
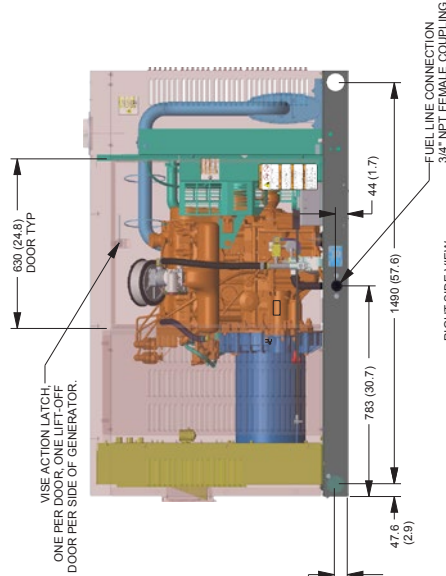

ENGINE/KW	ENCLOSURE MATERIAL	WEIGHT DATA		
		WEIGHT GENSET ONLY KG [LBS]	WEIGHT SHIPPING SKID KG [LBS]	WEIGHT SHIPPING WEIGHT KG [LBS]
1.5L/25KW	ST	392 [865]	30 [66]	422 [931]
1.5L/30KW	ST	406 [895]	30 [66]	436 [961]
1.5L/25KW	AL	352 [777]	30 [66]	382 [843]
1.5L/30KW	AL	366 [807]	30 [66]	396 [873]

DIMENSIONS: MM [INCH]

**25 & 30 kW**

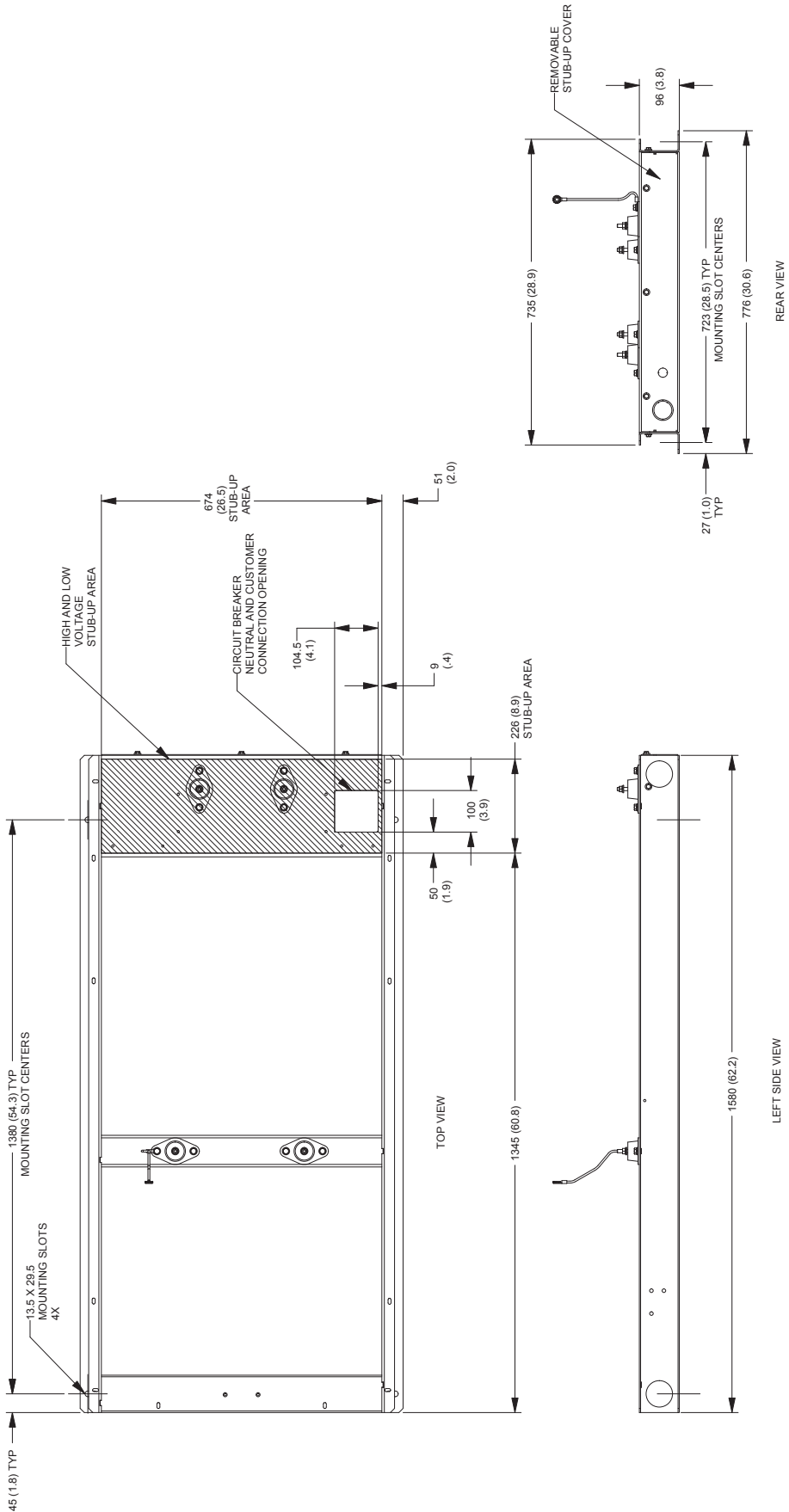

36, 45 & 60 kW

Drawing #0K8636-A (1 of 2)

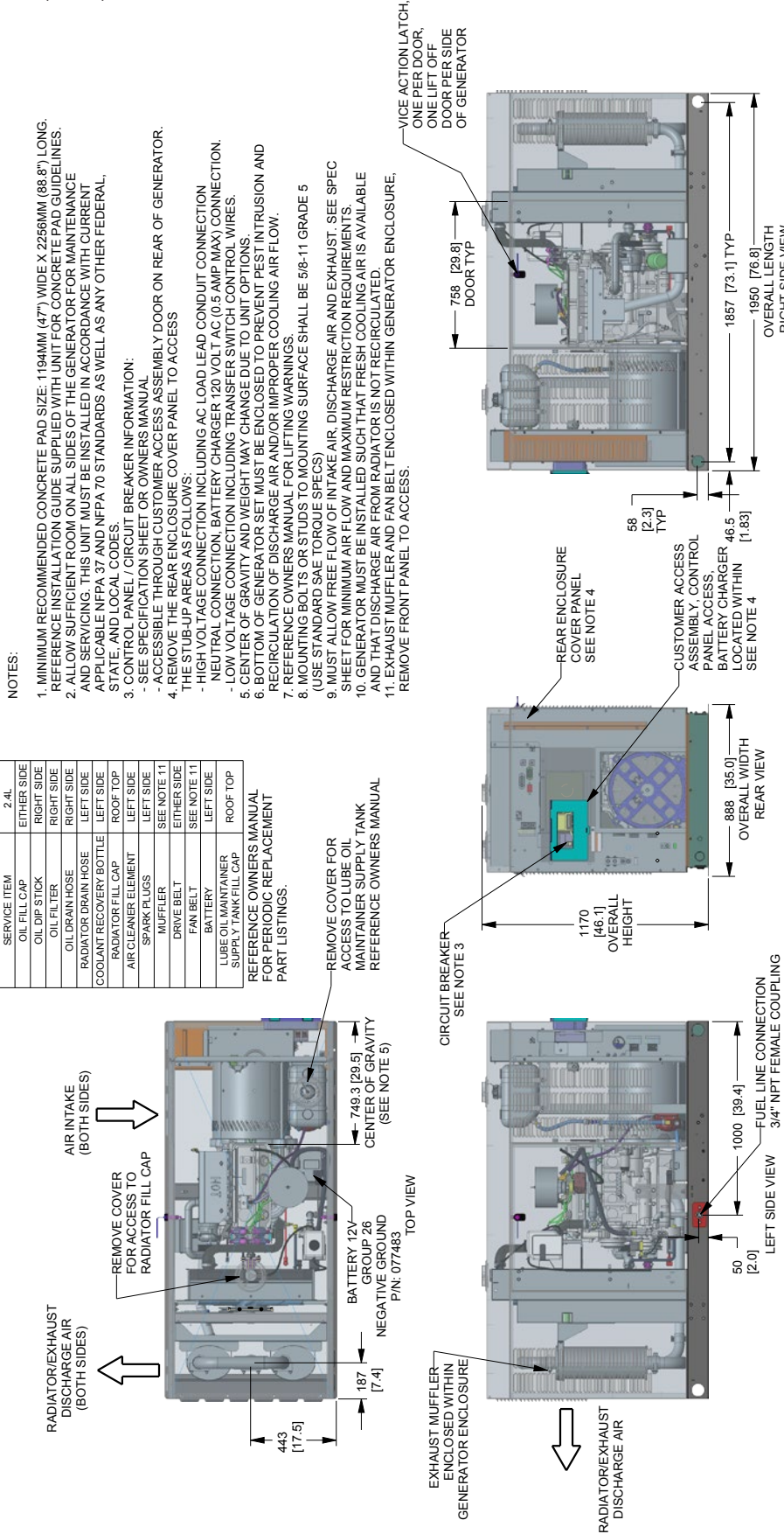

**WEIGHT DATA**

ENGINE/KW	ENCLOSURE MATERIAL	WEIGHT GENSET ONLY KG (LBS)	WEIGHT SHIPPING SKID KG (LBS)	SHIPPING WEIGHT KG (LBS)
2.4L 36KW	ST	569 [1255]	44 [98]	613 [1353]
2.4L 36KW	AL	545 [1202]	44 [98]	590 [1300]
2.4L 45KW	ST	596 [1313]	44 [98]	640 [1411]
2.4L 45KW	AL	572 [1260]	44 [98]	616 [1358]

DIMENSIONS: MM [INCH]



36, 45 & 60 kW

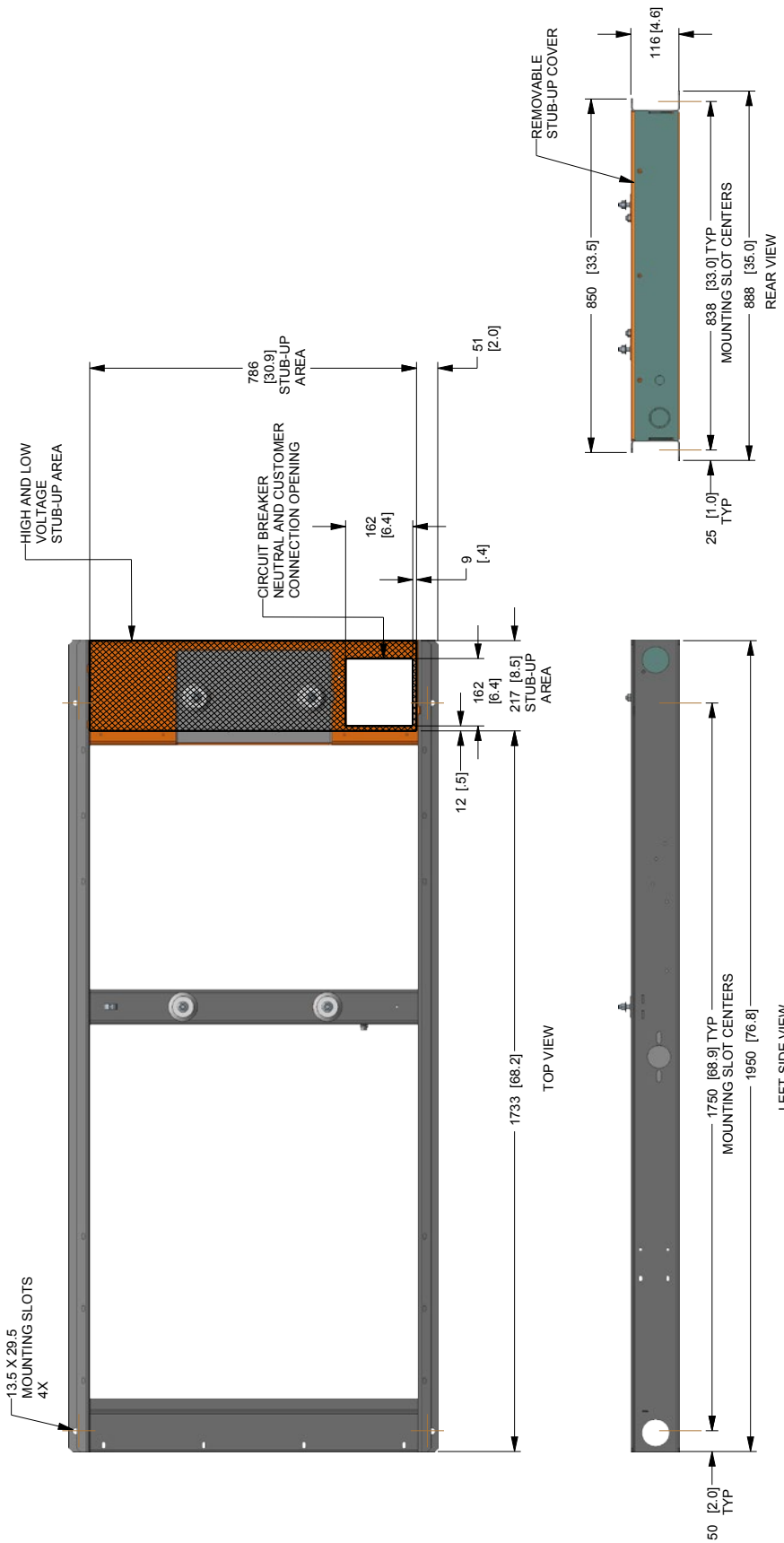

DIMENSIONS: MM [INCH]