

4326-4321 ELEMENTARY®

MANSFIELD®



Round Front, Vitreous China, Two-Piece Toilet

FEATURES

- Juvenile height toilet (10-3/8" high bowl)
- 1.28 gpf / 4.8 lpf high efficiency water consumption (HET)
- Round front, rimless bowl
- Includes slow close toilet seat
- Includes cover lock
- 2" flush valve
- Pilot operated anti-siphon fill valve
- 10" rough-in
- Chrome-plated trip lever
- 1-5/8" glazed trapway
- The Mansfield® limited lifetime warranty on china, One-year limited warranty on tank trim
- Available in White



COMPONENTS

MODEL #	DESCRIPTION	CODES/STANDARDS
4326-4321	Round front, two-piece toilet with slow close toilet seat. Includes installation hardware.	   HIGH EFFICIENCY TOILET ADA COMPLIANT*
4326	Round front, juvenile height toilet bowl with slow close seat.	
4321	Tank and cover with left hand, front-mount, chrome-plated, plastic trip lever and cover lock hardware.	
007474320	Elementary toilet seat, round front, slow close.	
TANK TRIM & REPLACEMENT PARTS		
005313700	Trip lever - chrome-plated, plastic trip lever, left hand	
90	Fill valve	
001304322	Flush valve	
005314320	Locking lid mechanism	
4320-LID	Tank lid	



*4326-4321 meets ADA requirements for ages 3-4.

4326-4321 ELEMENTARY®



Round Front, Vitreous China, Two-Piece Toilet

SPECIFICATIONS

MODEL #	DESCRIPTION	CODES/STANDARDS
4326-4321	Round front (1.28 gpf/4.8 lpf) two-piece toilet	   HIGH EFFICIENCY TOILET ADA COMPLIANT*

*4326-4321 meets ADA requirements for ages 3-4.

MATERIAL	Vitreous China
WATER PRESSURE RANGE	20 to 80 PSI
FLUSH SYSTEM	2" Flush Valve
WATER USAGE	1.28 gpf / 4.8 lpf
WATER SURFACE AREA	7-3/4" X 8"
ROUGH-IN	10"
MAP RATING	600 grams

TRAP DIAMETER	1-5/8"
TRAP SEAL	2-1/4"
SHIPPING WEIGHT	Model 4326 - 34 lbs. (15 kg) Model 4321 - 18 lbs. (8 kg)
WARRANTY	Vitreous China - Limited Lifetime Tank Trim - Limited One Year

TECHNICAL INFORMATION

Note: these dimensions are nominal and subject to change without notice.

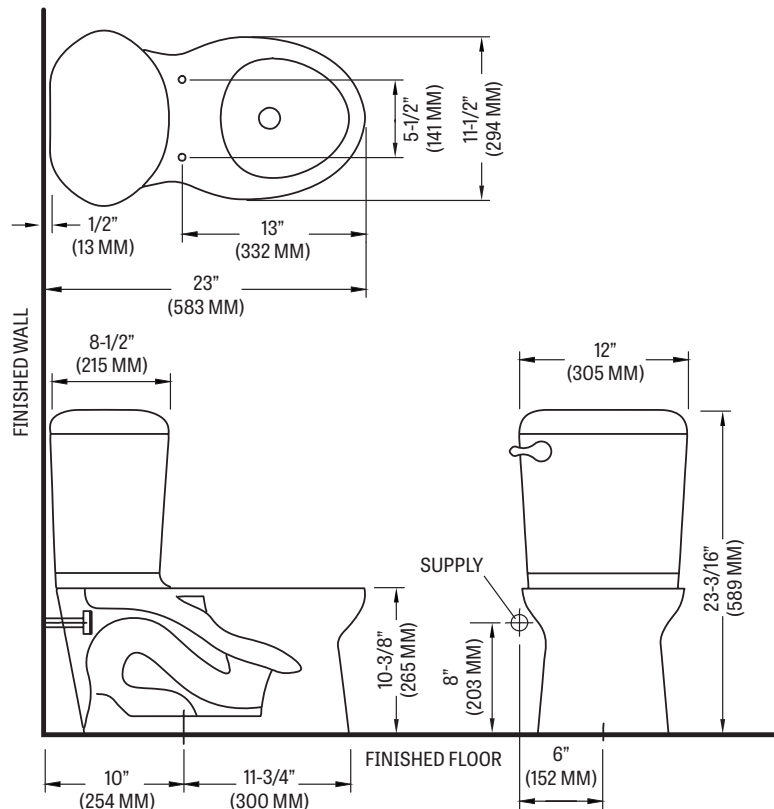

Fixture performance and specifications meet or exceed ASME A112.19.2/CSA B45.1 standards, and other state and local codes.