

146-153RH QUANTUM ONE™



Round Front, Vitreous China, Two-Piece Toilet

FEATURES

- High performance pressure-assist, high efficiency toilet (HET)
- Flushmate IV™ flushing technology
- 1.0 gpf / 3.8 lpf ultra-low water consumption
- SAVES almost 40% more water than conventional 1.6 gpf flushing systems
- Round front bowl
- 12" rough-in
- Model 49RH chrome-plated, metal trip lever
- 2-1/8" glazed trapway
- The Mansfield® limited lifetime warranty on china, Flushmate ten-year limited warranty on vessel
- Available in White, Biscuit and Bone







MODEL 146-153RH

Toilet seat not included



ROUND

COMPONENTS





MODEL #	DESCRIPTION	CODES/STANDARDS
146-153RH	Round front, pressure-assist, two-piece toilet. Less toilet seat and supply. Specify color.	   
146	Round front toilet bowl only. Less toilet seat. Specify color.	
153RH	Pressure-assist tank and cover only with right hand ,chrome-plated, metal trip lever. Less supply. Specify color.	
TANK OPTIONS		
153	Pressure-assist tank and cover only with left hand, chrome-plated, metal trip lever. Less supply. Specify color.	
154	Pressure-assist tank and cover only with chrome-plated metal push button actuator. Less supply. Specify color.	
TANK TRIM & REPLACEMENT PARTS		
49RH	Trip lever - chrome-plated, metal trip lever, right hand	
125-LID	Tank lid	
FLUSHMATE® 504	Pressure-assist flushing system. Separate warranty applies. Contact FLUSHMATE® at 1-800-533-3460.	

146-153RH QUANTUM ONE™



Round Front, Vitreous China, Two-Piece Toilet

SPECIFICATIONS

MODEL #	DESCRIPTION	CODES/STANDARDS
146-153RH	Round front (1.0 gpf / 3.8 lpf) two-piece toilet	   

MATERIAL	Vitreous China
WATER PRESSURE RANGE	35 to 80 PSI
FLUSH SYSTEM	Flushmate IV™ flushing technology
WATER USAGE	1.0 gpf / 3.8 lpf
WATER SURFACE AREA	9-3/4" X 11-1/2"
ROUGH-IN	12"
MaP RATING	1,000 grams

TRAP DIAMETER	2-1/8"
TRAP SEAL	2-3/4"
SHIPPING WEIGHT	Model 146 - 51 lbs. (23 kg) Model 153RH - 51 lbs. (23 kg)
WARRANTY	Vitreous China - Limited Lifetime Vessel - Limited Ten Year (Flushmate)

TECHNICAL INFORMATION

Note: these dimensions are nominal and subject to change without notice.

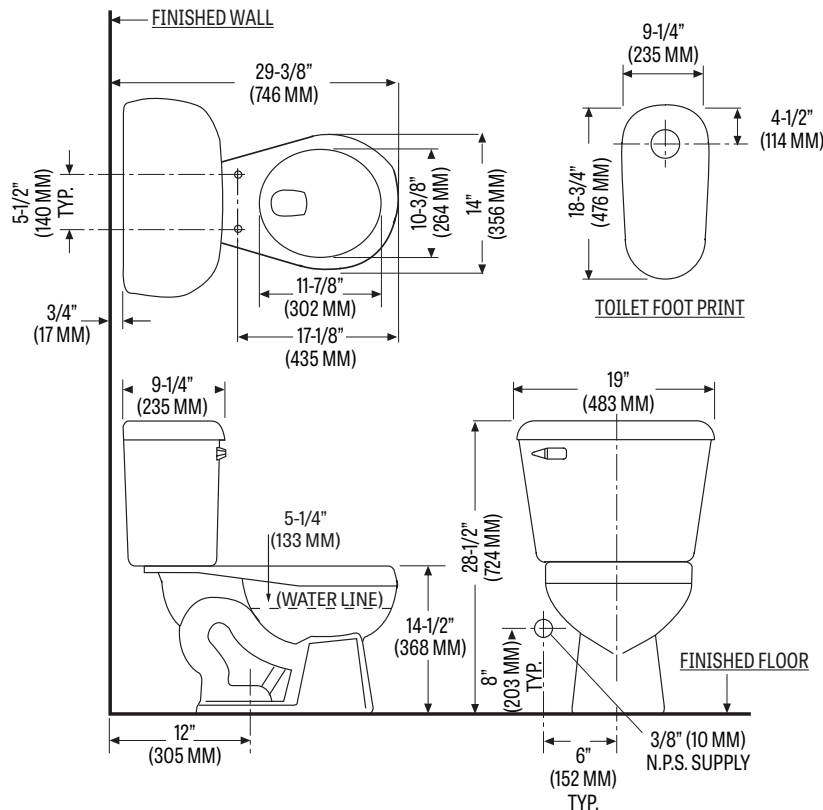

Fixture performance and specifications meet or exceed ASME A112.19.2-2013/CSA B45.1-13 standards, and other state and local codes.