

ITEM NO. 3781156 / MODEL NO. 5008550000



**BARRETT™ 3666****MANSFIELD®**

66" x 36" x 24", Acrylic, Swirl-Way® Whirlpool

**FEATURES**

- High gloss, easy-to-clean acrylic with fiberglass reinforcement
- Whirlpool hydromassage system uses fully controllable, high-pressure back and body jets for complete muscle relief
- Clean geometric lines
- Hydro-V back jet system with back and body jets
- All jets are directionally and flow adjustable
- Includes two pillows
- Rectangular model with center drain
- Pre-leveled legs for easy installation
- Integrated dual armrests for bather's comfort
- Dual back jets
- Spacious bathing well designed for two-person comfort
- Installation: Drop-In, Alcove or Undermount
- 10-year limited warranty on acrylic
- Available in White

**COMPONENTS**

MODEL #	DESCRIPTION	CODES/STANDARDS
5008550000	66" x 36" x 24" Rectangular Swirl-Way® Whirlpool. Drain not included.	  
ACCESSORIES		
<b>CAB-</b>	Cable Overflow Drain (White — 1330, Chrome — 1335, Everbrass — 1336, Brushed Nickel — 1337, Oil Rubbed Bronze — 1338, Matte Black — 1339)	
<b>TIP-</b>	Tip Toe Overflow Drain (Chrome — 1335, Everbrass — 1336, Brushed Nickel — 1337, Oil Rubbed Bronze — 1338, Matte Black — 1339)	
<b>SWAPOO</b>	Nailing Flange Kit (includes 14' PVC nailing flange, tacky tape and installation instructions)	



ITEM NO. 3781156 / MODEL NO. 5008550000

**BARRETT™ 3666****MANSFIELD®**

66" x 36" x 24", Acrylic, Swirl-Way® Whirlpool

**SPECIFICATIONS**

<b>MATERIAL</b>	Acrylic, fiberglass reinforced	<b>SOAKING DEPTH</b>	18-1/2"
<b>CONSTRUCTION</b>	Self contained, pre-plumbed whirlpool bath system mounted on pre-leveled base.	<b>NUMBER OF JETS</b>	16
<b>ELECTRICAL REQUIREMENTS</b>	One 120 volt, 20 amp GFCI dedicated circuit. Optional heater: separate 120 volt, 20 amp dedicated circuit.	<b>WATER CAPACITY</b>	60 gal. (min.) / 70 gal. (max)
		<b>FLOOR LOADING WEIGHT</b>	47 lbs. sq.ft.
		<b>SHIPPING WEIGHT</b>	Model 5008550000 - 170 lbs. (77 kg)
		<b>WHIRLPOOL PUMP</b>	9 amp
		<b>WARRANTY</b>	Acrylic - 10-Year

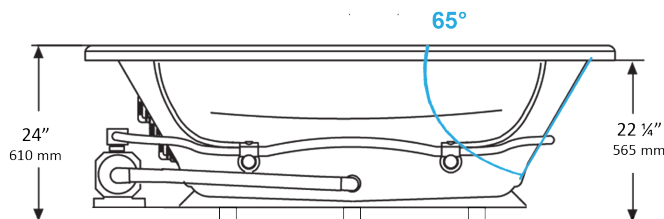
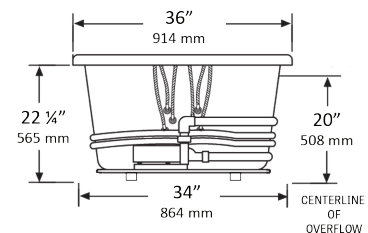
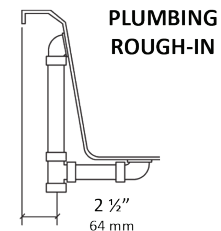
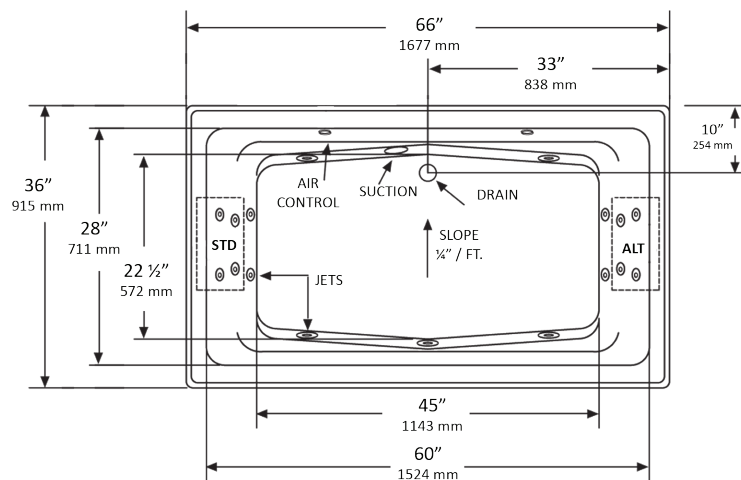
**TECHNICAL INFORMATION****Note:** these dimensions are nominal and subject to change without notice.**NOTES:**

1. Pump locations shown for clarity. Specify when ordering STD - Standard or ALT - Alternate.
2. Required pump motor access is 20" W x 15" H.
3. Measurements may vary 1/4" (+/-)
4. If a factory installed nailing flange is added to a unit, add 1/8" to each side flanged.
5. Removable apron is not available for this unit.
6. These dimensions are nominal and subject to change without notice.

