

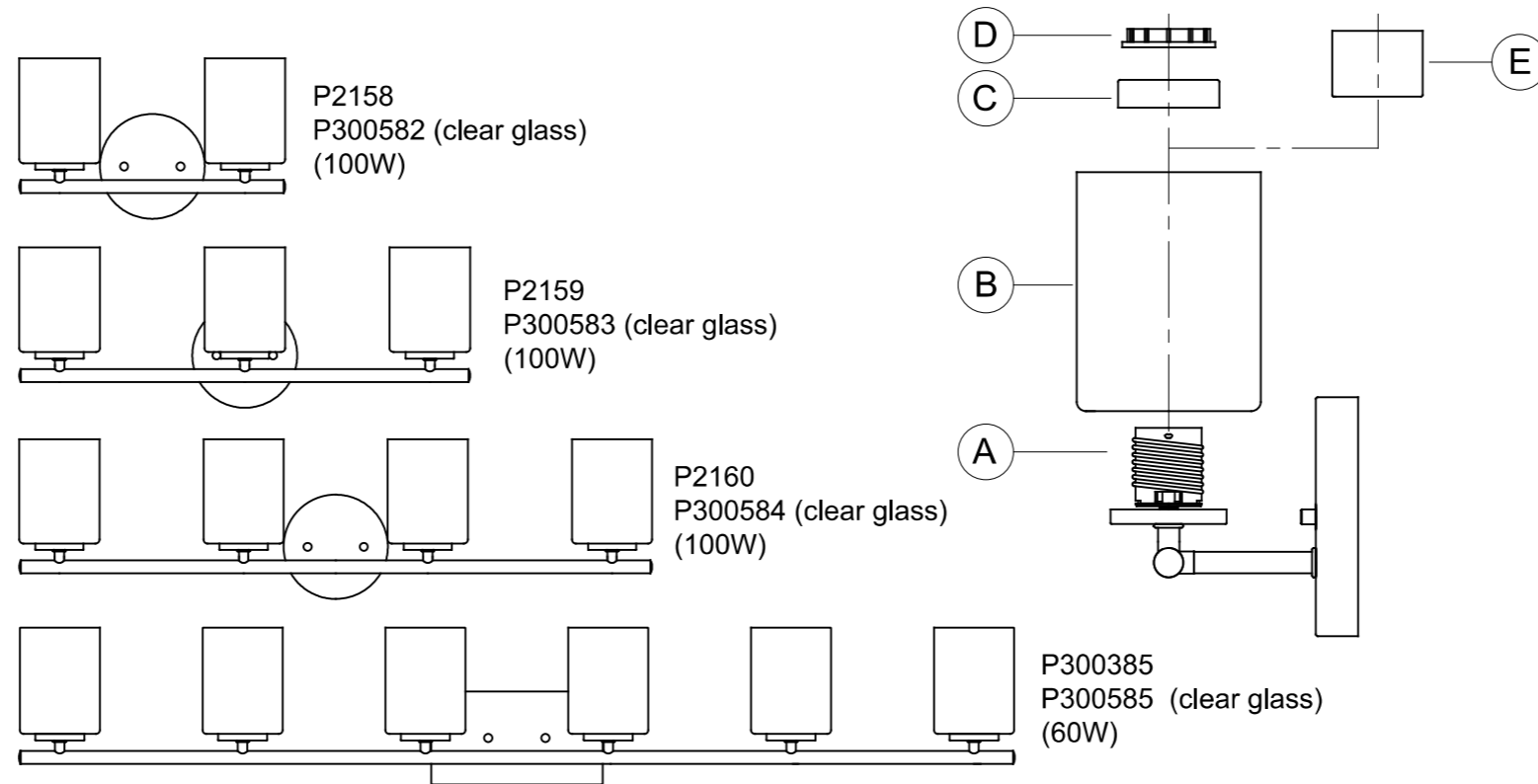

PACKAGE CONTENTS

PART	DESCRIPTION	QUANTITY			
		P2158	P2159	P2160	P300385
A	Fixture	1	1	1	1
B	Glass shade	2	3	4	6
C	Socket cover	2	3	4	6
D	Socket ring	2	3	4	6
E	Socket ring (for P300582, P300583, P300584, P300585)	2	3	4	6

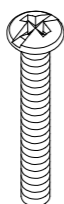
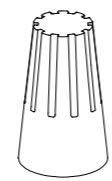
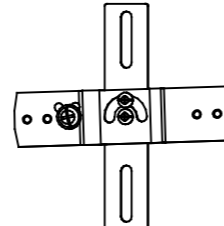

HARDWARE CONTENTS (not actual size)

AA 	BB 	CC 	DD 	EE 
Screw (#8-32) Qty:2	Wire nut Qty:3	Swivel mounting strap Qty:1	Hex nut (#8-32) Qty:2	Cylinder nut (#8-32) Qty:2



Missing parts? Please contact Customer Service at 1-800-447-0573,
8am-8pm (Eastern), Monday - Friday, or at customerservice@coletobrands.com



Safety Information

Please read and understand this entire manual before attempting to assemble, operate, or install the product.

CAUTION - RISK OF SHOCK:

Disconnect Power at the main circuit breaker panel or main fusebox before starting and during the installation.

CAUTION: All glass is fragile. Use care when handling glass shades and bulbs.

WARNING:

1. This fixture is intended for installation in accordance with the National Electrical Code (NEC) and all local code specifications. If you are not familiar with code requirements, installation by a certified electrician is recommended. Failure to adhere to these codes and instructions may result in serious injury and/or property damage and will void the warranty.

- Always be certain that electric power is turned off before cleaning.
- Only a soft damp cloth should be used. Harsh cleaning products may damage the finish.

Preparation

1. Before beginning installation, make sure all parts are included using the contents diagrams from page 1. If any part is missing or damaged, do not attempt to assemble, install or operate the product.
2. Estimated assembly time: 30 minutes.
3. Tools required for assembly (not included): Phillips screwdriver, pliers, wire stripper, safety glasses, electrical tape, ladder.

Care and Maintenance

Shut off main power supply before cleaning product or changing light bulbs. To clean, wipe with damp cloth. Do not use abrasive cleaners or cleaners that contain alcohol.

Assembly Instructions

1. Screw screws (AA) onto swivel mounting strap (CC) and use the hex nuts (DD) to secure it tight.

Hardware Used

AA	Screw		X2
CC	Swivel mounting strap		X1
DD	Hex nut		X2

2. Attach assembled parts from step 1 onto junction box, using the mounting screws supplied with the junction box (not included).

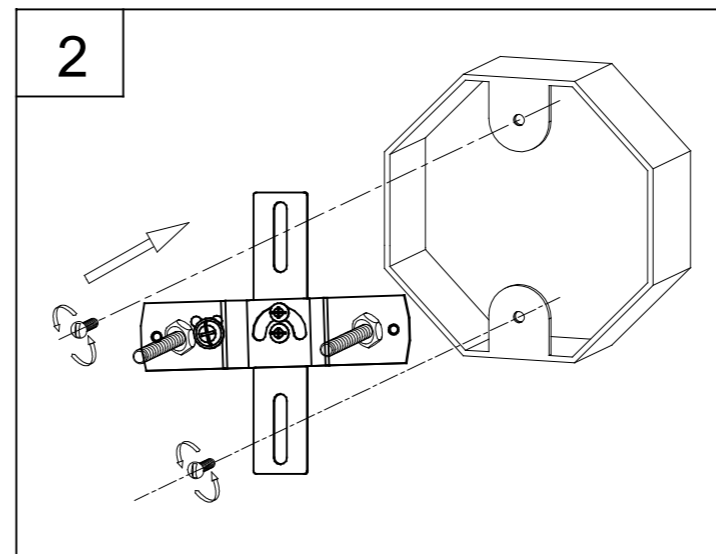
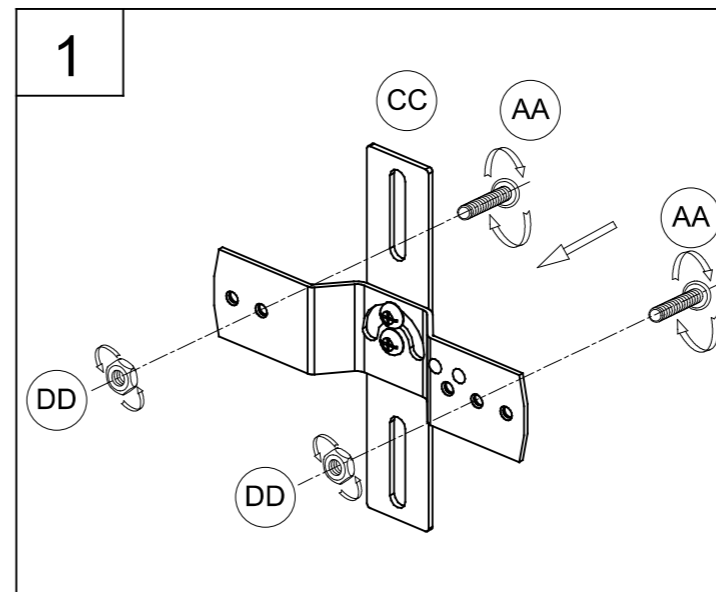

Assembly Instructions

3. Strip 3/8" of insulation from the electrical wire ends. Using wire nuts (BB), connect white fixture wire to the white supply wire from the junction box; connect the black fixture wire to the black supply wire.

Connect the fixture ground wire and supply ground wire using a wire nut or by fastening to the ground screw on the swivel mounting strap. Push all wire connections into the outlet box.

BB Wire nut X3

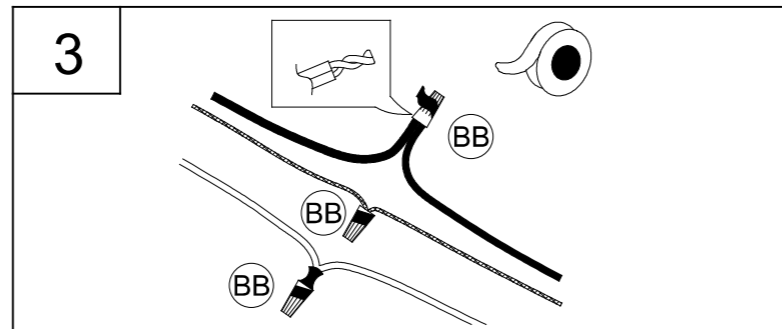

4. Attach fixture (A) to screws (AA) using cylinder nuts (EE). Secure tightly.

EE Cylinder nut X2 Mounted UP or DOWN

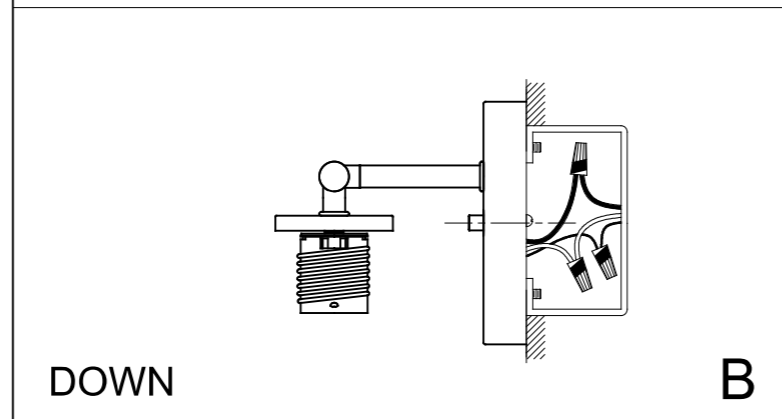
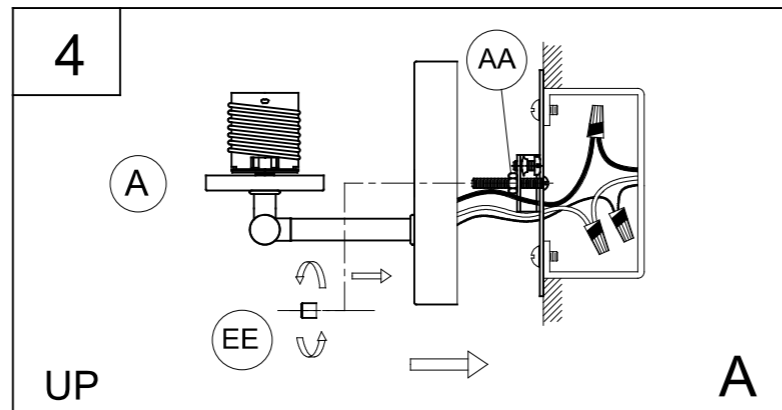

5. Attach glass (B) to fixture (A) and use socket ring (C) to secure tight.

NOTE: For P300582, P300583, P300584, P300585 clear glass shade, use socket ring (E) and tighten the glass shade (B) onto the fixture (A) socket.

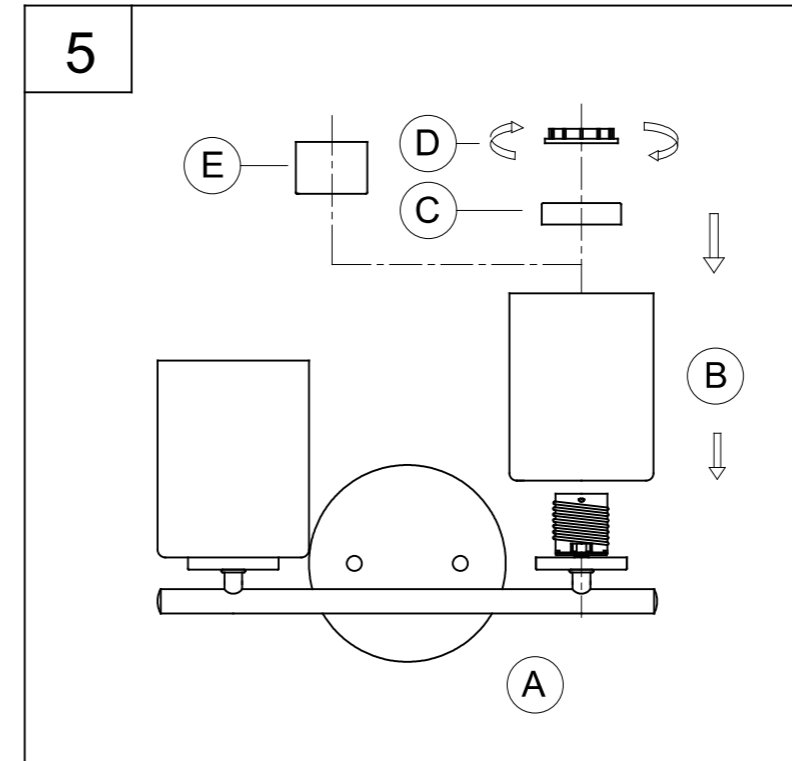

6. Screw lamp (not included) into fixture socket.

Use 60 or 100-watt MAX (see page 1) incandescent medium base lamp, SBCFL or SBLED.

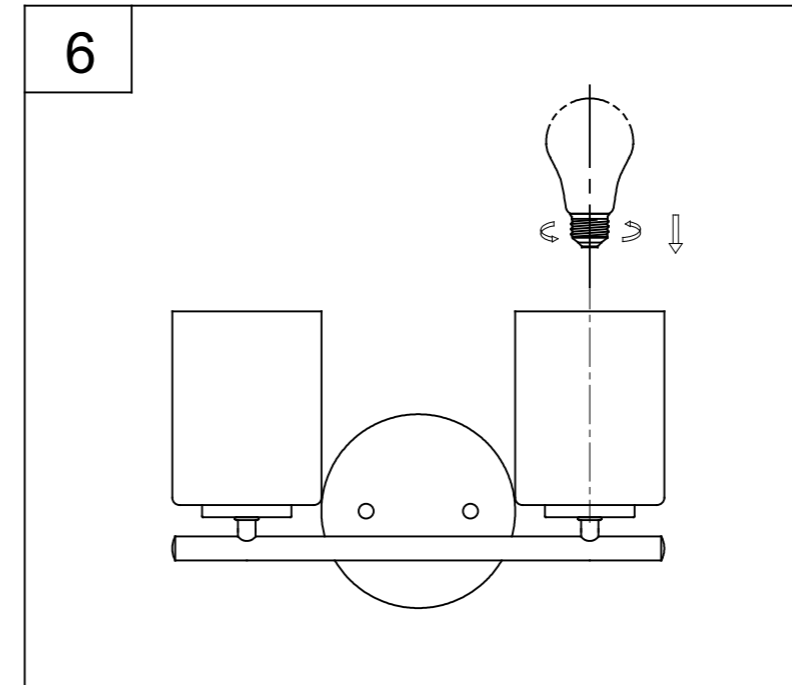

WARRANTY AND EXCLUSIVE REMEDY: Progress products, when properly installed and under normal conditions of use, are warranted to our customers only to be free from defects in material and workmanship at time of shipment. All warranty claims must be asserted within one year from date of purchase of the subject items; thereafter, warranty claims will not be honored. Customers' sole remedy for a warranty claim or otherwise shall be limited to repair or replacement of the subject product if it is shown to have been defective in material or workmanship at time of shipment. Progress's sole and maximum liability for a defective product shall never exceed the cost of the subject product. **EXCEPT FOR SUCH A WARRANTY AND EXCLUSIVE REMEDY AS STATED (AND THE EXPRESS WARRANTY OF TITLE), WE DISCLAIM ALL OTHER WARRANTIES, WHETHER EXPRESS OR IMPLIED, AND SPECIFICALLY DISCLAIM THE IMPLIED WARRANTIES OF MERCHANTABILITY AND FITNESS FOR A PARTICULAR PURPOSE. IN NO EVENT SHALL WE BE LIABLE TO CUSTOMER IN WARRANTY, CONTRACT, NEGLIGENCE, STRICT LIABILITY OR OTHERWISE, FOR ANY DAMAGES, WHETHER INCIDENTAL OR CONSEQUENTIAL, WHICH ARE ALLEGED TO BE CAUSED BY ONE OR MORE OF OUR PRODUCTS, BEYOND THE COST TO THE CUSTOMER OF THE SUBJECT PRODUCT OR PRODUCTS.** Therefore, the customer's sole and exclusive remedy against us for breach of the warranty, breach of contract or negligence or strict liability or otherwise shall be limited to repair or replacement of the subject product at our option (excluding installation and removal charges which shall not be our liability) or, if we choose, refund of the purchase price. In no case does our warranty and exclusive remedy extend to anybody other than our customers. Our customers are not authorized to extend warranties or remedies on our behalf to anyone. Such unauthorized extensions of warranties or remedies by the customer shall remain customer's responsibility. Customer is responsible for determining the suitability of our products for customer's use or resale, or for incorporating them into objects or for applications which customer designs, assembles, constructs or manufactures.

Instrucciones de ensamblaje e instalación

Lea cuidadosamente las instrucciones y desconecte la electricidad del cortacircuitos principal antes de iniciar la instalación.

PRECAUCIÓN - RIESGO DE DESCARGA ELÉCTRICA:

Desconecte la electricidad en el panel principal del interruptor automático o caja principal de fusibles antes de comenzar y durante la instalación.

PRECAUCION - El vidrio es frágil; tenga cuidado al manipular el (los) elemento(s) de vidrio y/o la(s) bombilla(s).

ADVERTENCIA:

1. Este accesorio está destinado a la instalación de acuerdo con el National Electrical Code (NEC) y todas las especificaciones del código local. Si no está familiarizado con los requisitos del código, la instalación se recomienda un electricista certificado. No cumplir con estos códigos e instrucciones puede resultar en lesiones graves y/ o en daños a la propiedad y anulará la garantía.

LIMPIEZA:

- Asegúrese siempre de que la corriente eléctrica esté apagada antes de limpiar.
- Debe usarse solamente un paño húmedo y suave. Productos de limpieza abrasivos pueden dañar el acabado.

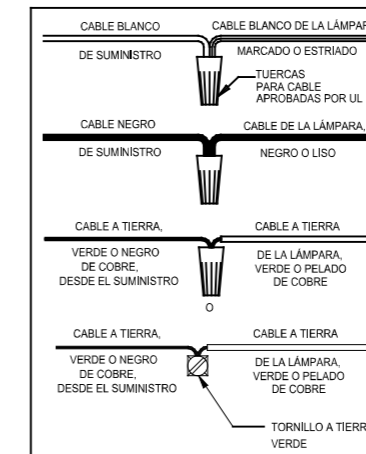

Instructions d'Assemblage et Installation

Lire les instructions avec soin et couper le courant au disjoncteur central avant de commencer l'installation.

ATTENTION - RISQUE DE DÉCHARGES ÉLECTRIQUES:

Couper le courant au niveau du panneau du disjoncteur du circuit principal ou de la boîte à fusibles principale avant de procéder à l'installation.

MISE EN GARDE - Le verre est toujours fragile; maniez le(s) composant(s) et/ou l' (les) ampoule(s) avec prudence.

ATTENTION:

1. Ce luminaire doit être installé conformément aux codes d'électricité nationaux (NEC) et satisfaire toutes les spécifications des codes locaux. Si vous ne connaissez pas les exigences de ces codes, il est recommandé de confier l'installation à un électricien certifié. Ne pas se conformer à ces codes et directives pourrait provoquer des blessures sérieuses et/ou des dommages matériels et rendre la garantie non valide.

NETTOYAGE:

- Soyez toujours certain que l'alimentation électrique du luminaire est fermée avant le nettoyage.
- N'utilisez qu'un chiffon doux humide. Les produits de nettoyage acides/abrasifs peuvent endommager le fini.

