

# 5987CTK VANQUISH®



# MANSFIELD®

Elongated Front, SmartHeight™, Vitreous China, Two-Piece Toilet, Complete Toilet Kit



## FEATURES

- Complete toilet kit (CTK)
- 1.6 gpf / 6.0 lpf low water consumption
- Revolutionary seat design with side-mount hinges for easy cleaning
- PuraClean® easy-to-clean glazed surface
- Elongated front, SmartHeight™ bowl
- 3' Rigid Flapper flush valve – requires less force to flush, is more consistent and uses a simple universal repair part/seal
- Fluidmaster® Pilot anti-siphon fill valve
- 12" rough-in
- SmartFasten™ 2-bolt tank-to-bowl connection
- Model 39 decorative metal trip lever
- 2" glazed trapway
- The Mansfield® limited lifetime warranty on china, Five-year limited warranty on tank trim & seat
- Available in white



<b>MODEL 5987CTK</b>			
Toilet seat included	CTK	ELONGATED	SMARTHEIGHT ADA
Complete Toilet Kit			

## COMPONENTS

MODEL #	DESCRIPTION	CODES/STANDARDS
<b>5987CTK</b>	Elongated front, SmartHeight™ complete toilet kit. Includes slow close toilet seat, tank and bowl, flange bolts, wax ring with polyethylene flange and instructions. Less supply.	 
<b>4987</b>	Elongated front, SmartHeight™ bowl with side-mount seat.	
<b>3987</b>	Tank and lid only. With left hand, chrome-plated metal trip lever. Less supply.	
<b>SB4000</b>	Patented slow close seat with side-mount hinges*	

TANK TRIM & REPLACEMENT PARTS	
<b>39</b>	Trip Lever - chrome-plated metal trip lever, left hand
<b>400A</b>	Fluidmaster® Pilot anti-siphon fill valve
<b>2206</b>	Pilot operated fill valve
<b>3987-1112</b>	3' Rigid Flapper flush valve
<b>630-0030</b>	Replacement flush valve seal
<b>3987-LID</b>	Tank lid

\*U.S. Patent No. 9809967





# 5987CTK VANQUISH®



Elongated Front, SmartHeight™, Vitreous China, Two-Piece Toilet, Complete Toilet Kit

## SPECIFICATIONS

MODEL #	DESCRIPTION	CODES/STANDARDS
5987CTK	Elongated front, SmartHeight™ (1.6 gpf/6.0 lpf) two-piece toilet kit	 
<b>MATERIAL</b>	Vitreous China	
<b>WATER PRESSURE RANGE</b>	20 to 80 PSI	
<b>FLUSH SYSTEM</b>	3' MagnaFlush™ Flushing Technology	
<b>WATER USAGE</b>	1.6 gpf / 6.0 lpf	
<b>WATER SURFACE AREA</b>	8' X 7'	
<b>ROUGH-IN</b>	12"	
<b>MAP RATING</b>	1,000 grams	
<b>TRAP DIAMETER</b>	2'	
<b>TRAP SEAL</b>	2-3/8"	
<b>SHIPPING WEIGHT</b>	Model 5987CTK - 98 lbs. (44 kg)	
<b>WARRANTY</b>	Vitreous China - Limited Lifetime Tank Trim & Seat - Limited Five-Year	

## TECHNICAL INFORMATION

**Note:** these dimensions are nominal and subject to change without notice.

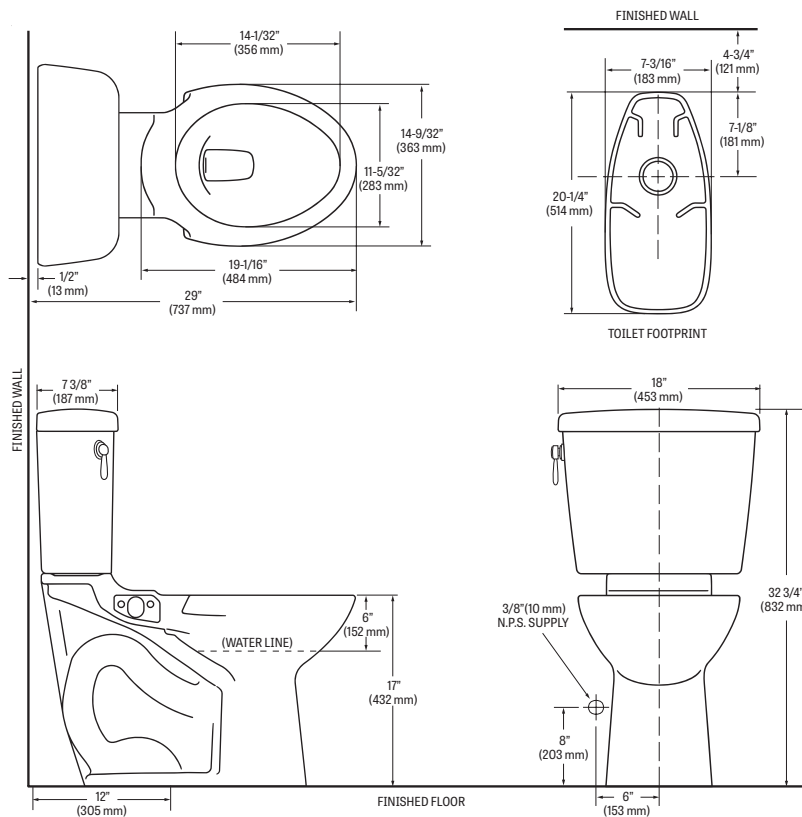

Fixture performance and specifications meet or exceed ASME A112.19.2/CSA B45.1 standards, and other state and local codes.

