

385-377 SUMMIT® PRO 1.28







Elongated Front, SmartHeight™, Vitreous China, 10" Rough-In, Two-Piece Toilet

FEATURES

- High performance MagnaFlush™ flushing technology
- 1.28 gpf / 4.8 lpf high efficiency water consumption
- Elongated front, SmartHeight™ bowl (ADA compliant)
- SmartFasten™ 3-bolt tank-to-bowl connection
- 3" Rigid Flapper flush valve – requires less force to flush, is more consistent and uses a simple universal repair part/seal
- Fluidmaster® pilot operated anti-siphon fill valve
- 10" rough-in
- Model 59 color match, metal trip lever
- 2" glazed trapway
- The Mansfield® limited lifetime warranty on china, Five-year limited warranty on tank trim
- Available in White



COMPONENTS





MODEL #	DESCRIPTION	CODES/STANDARDS
385-377	Elongated front, SmartHeight™, two-piece toilet. Less toilet seat and supply.	   
385	Elongated front, SmartHeight™ toilet bowl only. Less supply.	
377	Tank and cover only, with left hand, front-mount, color match, metal trip lever. Less supply.	
TANK TRIM & REPLACEMENT PARTS		
59	Trip lever - color match, metal trip lever, left hand	
2036-1212	Summit® 1.28 rigid flapper flush valve	
400A	Fluidmaster® anti-siphon pilot fill valve	
2206	Anti-siphon pilot fill valve (compatible replacement)	
630-0030	Replacement flush valve seal	
386-LID	Tank lid	

385-377 SUMMIT[®] PRO 1.28



Elongated Front, SmartHeight™, Vitreous China, 10" Rough-In, Two-Piece Toilet

SPECIFICATIONS

MODEL #	DESCRIPTION	CODES/STANDARDS
385-377	Elongated front, SmartHeight™ (1.28 gpf/4.8 lpf) two-piece toilet	   

MATERIAL	Vitreous China
WATER PRESSURE RANGE	20 to 80 PSI
FLUSH SYSTEM	MagnaFlush™ flushing technology
WATER USAGE	1.28 gpf / 4.8 lpf
WATER SURFACE AREA	9" X 10"
ROUGH-IN	10"
MaP RATING	1,000 grams

TRAP DIAMETER	2"
TRAP SEAL	2-3/8"
SHIPPING WEIGHT	Model 385 - 54 lbs. (24.4 kg) Model 377 - 36 lbs. (16.3 kg)
WARRANTY	Vitreous China - Limited Lifetime Tank Trim - Limited Five Year

TANK OPTIONS	
377RH	Variation of model 377, with right hand trip lever.

TECHNICAL INFORMATION

Note: these dimensions are nominal and subject to change without notice.

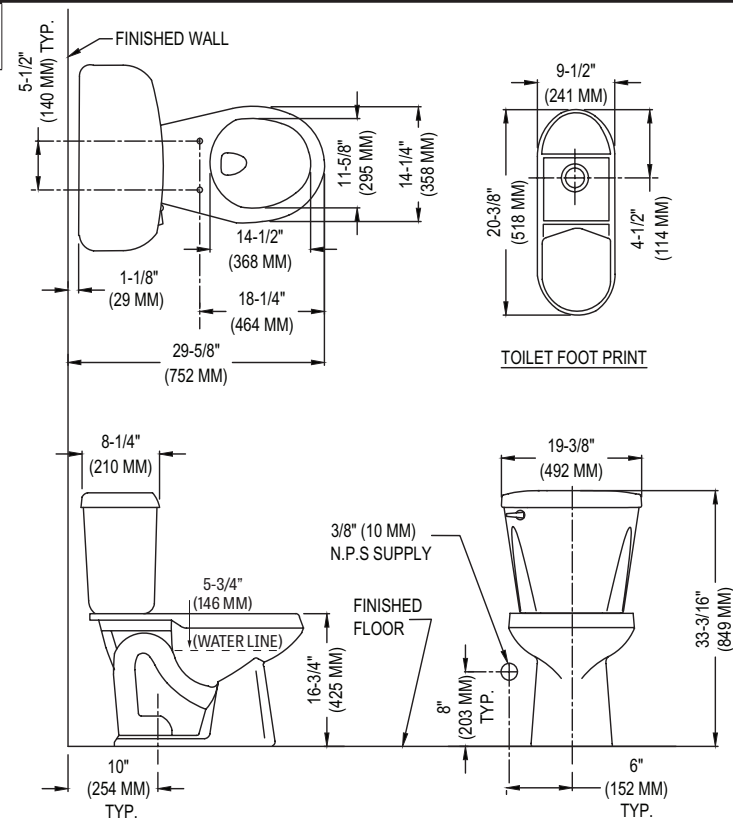

Fixture performance and specifications meet or exceed ASME A112.19.2-2013/CSA B45.1-13 standards, and other state and local codes.