

139NS-3174 ALTO[®] 1.28

MANSFIELD[®]

Elongated Front, SmartHeight[™] Vitreous China, Two-Piece Toilet

FEATURES

- 3-bolt SmartFaster[™] tank-to-bowl connection
- 1.28 gpf / 4.8 lpf high efficiency water consumption
- Uses 20% less water than conventional toilets
- Elongated front, SmartHeight[™] bowl
- 3-2" hybrid flapper flush valve
- Fluidmaster[®] anti-siphon pilot fill valve
- Lined tank for reduced condensation
- 10" rough-in
- Model 31 color-match, plastic trip lever
- 2" glazed trapway
- The Mansfield[®] Limited Lifetime Warranty
- Available in White





MODEL 139NS-3174

Toilet seat not included



COMPONENTS

MODEL #	DESCRIPTION	CODES/STANDARDS
139NS-3174	Elongated front, SmartHeight [™] two-piece toilet	   <p>HIGH EFFICIENCY TOILET ADA COMPLIANT</p>
139NS	Elongated front, SmartHeight [™] toilet bowl only. Less toilet seat. Specify color.	
3174	Tank and cover only with left hand, front-mount, color-match, plastic trip lever. Fluidmaster [®] anti-siphon pilot fill valve and tank liner. Less supply.	

TANK TRIM & REPLACEMENT PARTS

31	Trip lever - color-match, plastic trip lever, left hand
228	3-2" Hybrid flapper flush valve
400A	Fluidmaster [®] anti-siphon pilot fill valve
2206	Anti-siphon pilot fill valve (compatible replacement)
630-0207	3" Replacement flapper kit
160-LID	Tank lid





139NS-3174 ALTO[®] 1.28



Elongated Front, SmartHeight™ Vitreous China, Two-Piece Toilet

SPECIFICATIONS

MODEL #	DESCRIPTION	CODES/STANDARDS
139NS-3174	Elongated front, SmartHeight™ (1.28 gpf / 4.8 lpf) two-piece toilet	   HIGH EFFICIENCY TOILET C ADA COMPLIANT

MATERIAL	Vitreous China
WATER PRESSURE RANGE	20 to 80 PSI
FLUSH SYSTEM	3-2" Hybrid flapper flush valve
WATER USAGE	1.28 gpf / 4.8 lpf
WATER SURFACE AREA	9' X 10'
ROUGH-IN	10'
MAP RATING	800 grams

TRAP DIAMETER	2'
TRAP SEAL	2-3/8'
SHIPPING WEIGHT	Model 139NS - 56 lbs. (24 kg) Model 3174 - 34 lbs. (15 kg)
WARRANTY	Vitreous China - Limited Lifetime Tank Trim - Limited One Year

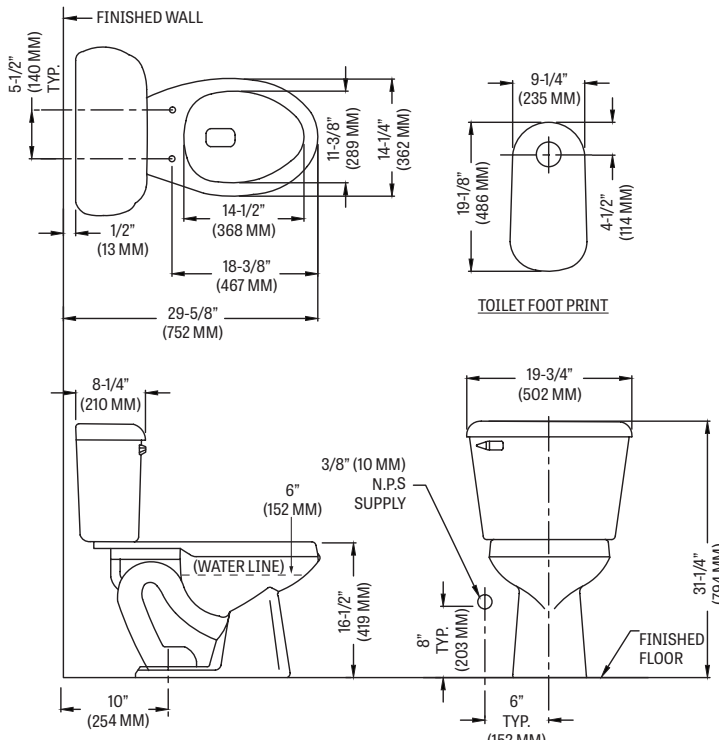
TANK OPTIONS	TECHNICAL INFORMATION										
	Note: these dimensions are nominal and subject to change without notice.										
<table border="1"> <tbody> <tr> <td>3173</td> <td>Standard 1.28 gpf configuration: 3-2" hybrid flapper flush valve, Fluidmaster® anti-siphon pilot fill valve, left hand, color-match trip lever.</td> </tr> <tr> <td>3173RH</td> <td>Variation of model 3173, with right hand, color-match trip lever.</td> </tr> <tr> <td>3165</td> <td>Variation of model 3173, with cover lock.</td> </tr> <tr> <td>3174</td> <td>Variation of model 3173, with tank liner.</td> </tr> <tr> <td>3120</td> <td>Variation of model 3173, with left hand, chrome trip lever.</td> </tr> </tbody> </table>	3173	Standard 1.28 gpf configuration: 3-2" hybrid flapper flush valve, Fluidmaster® anti-siphon pilot fill valve, left hand, color-match trip lever.	3173RH	Variation of model 3173, with right hand, color-match trip lever.	3165	Variation of model 3173, with cover lock.	3174	Variation of model 3173, with tank liner.	3120	Variation of model 3173, with left hand, chrome trip lever.	 <p>The technical drawing includes three views: a top-down view of the bowl, a side view of the bowl and tank, and a top-down view of the toilet footprint. Dimensions are provided in inches and millimeters. Key dimensions include: finished wall to bowl center (5-1/2" TYP.), bowl width (14-1/2" and 18-3/8"), bowl depth (11-3/8" and 14-1/4"), tank width (19-3/4"), tank height (31-1/4"), and rough-in distance (10").</p>
3173	Standard 1.28 gpf configuration: 3-2" hybrid flapper flush valve, Fluidmaster® anti-siphon pilot fill valve, left hand, color-match trip lever.										
3173RH	Variation of model 3173, with right hand, color-match trip lever.										
3165	Variation of model 3173, with cover lock.										
3174	Variation of model 3173, with tank liner.										
3120	Variation of model 3173, with left hand, chrome trip lever.										

Fixture performance and specifications meet or exceed ASME A112.19.2/CSA B45.1 standards, and other state and local codes.

