

388-377RH SUMMIT[®] PRO 1.28







Round Front, SmartHeight™, Vitreous China, Two-Piece Toilet

FEATURES

- High performance MagnaFlush™ flushing technology
- 1.28 gpf / 4.8 lpf high efficiency water consumption
- Round front, SmartHeight™ bowl
- SmartFasten™ 3-bolt tank-to-bowl connection
- 3" Rigid Flapper flush valve – requires less force to flush, is more consistent and uses a simple universal repair part/seal
- Fluidmaster® pilot operated anti-siphon fill valve
- 12" rough-in
- Model 59RH color match, metal trip lever
- 2" glazed trapway
- The Mansfield® limited lifetime warranty on china, Five-year limited warranty on tank trim
- Available in White



COMPONENTS

MODEL #	DESCRIPTION	CODES/STANDARDS
388-377RH	Round front, SmartHeight™, two-piece toilet. Less toilet seat and supply.	   
388	Round front, SmartHeight™ toilet bowl only. Less supply.	
377RH	Tank and cover only, with right hand, front-mount, color match, metal trip lever. Less supply.	
TANK TRIM & REPLACEMENT PARTS		
59RH	Trip lever - color match, metal trip lever, right hand	
2036-1212	Summit® 1.28 rigid flapper flush valve	
400A	Fluidmaster® anti-siphon pilot fill valve	
2206	Anti-siphon pilot fill valve (compatible replacement)	
630-0030	Replacement flush valve seal	
386-LID	Tank lid	





When properly installed, this product meets the requirements for the Americans with Disabilities Act of 1990 (ADA). Refer to local plumbing codes, as they may vary by location and application.

388-377RH SUMMIT[®] PRO 1.28



Round Front, SmartHeight™, Vitreous China, Two-Piece Toilet

SPECIFICATIONS

MODEL #	DESCRIPTION	CODES/STANDARDS
388-377RH	Round front, SmartHeight™ (1.28 gpf/4.8 lpf) two-piece toilet	   

MATERIAL	Vitreous China
WATER PRESSURE RANGE	20 to 80 PSI
FLUSH SYSTEM	MagnaFlush™ flushing technology
WATER USAGE	1.28 gpf / 4.8 lpf
WATER SURFACE AREA	8" X 9"
ROUGH-IN	12"
MaP RATING	1,000 grams

TRAP DIAMETER	2"
TRAP SEAL	2-1/4"
SHIPPING WEIGHT	Model 388 - 52 lbs. (23.5 kg) Model 377RH - 36 lbs. (16.3 kg)
WARRANTY	Vitreous China - Limited Lifetime Tank Trim - Limited Five Year

TANK OPTIONS	
377	Variation of model 377RH, with left hand trip lever.

TECHNICAL INFORMATION

Note: these dimensions are nominal and subject to change without notice.

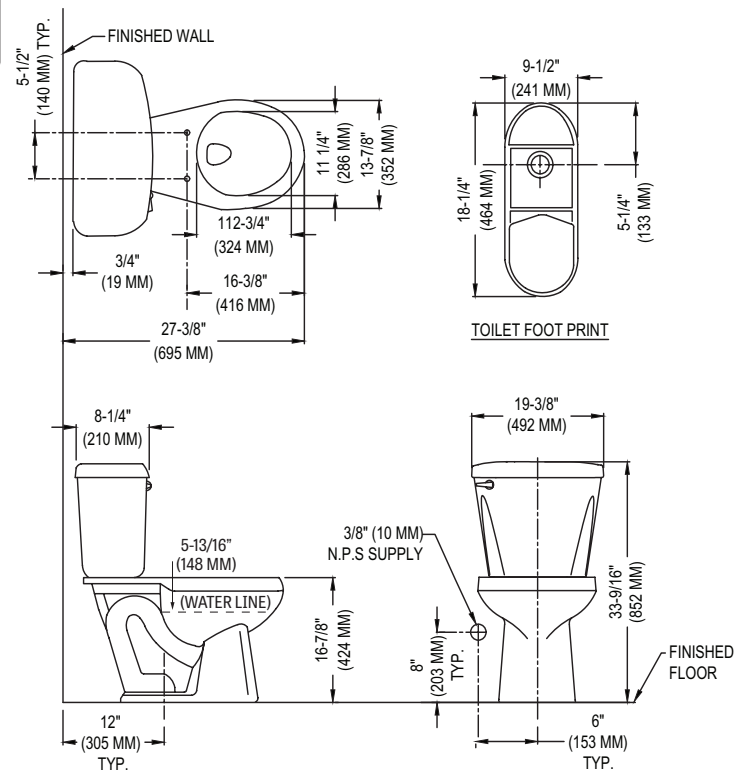

Fixture performance and specifications meet or exceed ASME A112.19.2-2013/CSA B45.1-13 standards, and other state and local codes.