

# 139NS-3120 ALTO<sup>®</sup> 1.28

# MANSFIELD<sup>®</sup>

Elongated Front, SmartHeight<sup>™</sup> Vitreous China, Two-Piece Toilet

## FEATURES

- 3-bolt SmartFaster<sup>™</sup> tank-to-bowl connection
- 1.28 gpf / 4.8 lpf high efficiency water consumption
- Uses 20% less water than conventional toilets
- Elongated front, SmartHeight<sup>™</sup> bowl
- 3-2" hybrid flapper flush valve
- Fluidmaster<sup>®</sup> anti-siphon pilot fill valve
- 10" rough-in
- Model 31 chrome-plated, plastic trip lever
- 2" glazed trapway
- The Mansfield<sup>®</sup> Limited Lifetime Warranty
- Available in White



**MODEL 139NS-3120**

Toilet seat not included





ELONGATED



SMARTHEIGHT ADA

## COMPONENTS

MODEL #	DESCRIPTION	CODES/STANDARDS
<b>139NS-3120</b>	Elongated front, SmartHeight <sup>™</sup> two-piece toilet	   <p>HIGH EFFICIENCY TOILET    C    ADA COMPLIANT</p>
<b>139NS</b>	Elongated front, SmartHeight <sup>™</sup> toilet bowl only. Less toilet seat. Specify color.	
<b>3120</b>	Tank and cover only with left hand, front-mount, chrome-plated, plastic trip lever. Fluidmaster <sup>®</sup> anti-siphon pilot fill valve. Less supply.	
TANK TRIM & REPLACEMENT PARTS		
<b>31</b>	Trip lever - chrome-plated, plastic trip lever, left hand	
<b>228</b>	3-2" Hybrid flapper flush valve	
<b>400A</b>	Fluidmaster <sup>®</sup> anti-siphon pilot fill valve	
<b>2206</b>	Anti-siphon pilot fill valve (compatible replacement)	
<b>630-0207</b>	3" Replacement flapper kit	
<b>160-LID</b>	Tank lid	





# 139NS-3120 ALTO<sup>®</sup> 1.28



Elongated Front, SmartHeight™ Vitreous China, Two-Piece Toilet

## SPECIFICATIONS

MODEL #	DESCRIPTION	CODES/STANDARDS
139NS-3120	Elongated front, SmartHeight™ (1.28 gpf / 4.8 lpf) two-piece toilet	  

MATERIAL	Vitreous China
WATER PRESSURE RANGE	20 to 80 PSI
FLUSH SYSTEM	3-2" Hybrid flapper flush valve
WATER USAGE	1.28 gpf / 4.8 lpf
WATER SURFACE AREA	9' X 10'
ROUGH-IN	10'
MAP RATING	800 grams

TRAP DIAMETER	2'
TRAP SEAL	2-3/8'
SHIPPING WEIGHT	Model 139NS - 56 lbs. (24 kg) Model 3120 - 34 lbs. (15 kg)
WARRANTY	Vitreous China - Limited Lifetime Tank Trim - Limited One Year

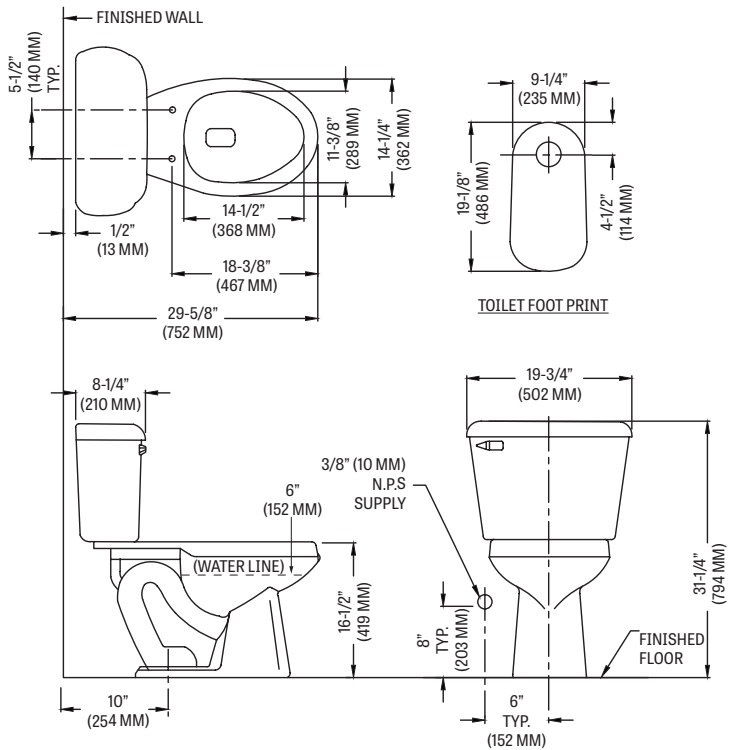
TANK OPTIONS	TECHNICAL INFORMATION										
	<b>Note:</b> these dimensions are nominal and subject to change without notice.										
<table border="1"> <tbody> <tr> <td>3173</td> <td>Standard 1.28 gpf configuration: 3-2" hybrid flapper flush valve, Fluidmaster<sup>®</sup> anti-siphon pilot fill valve, left hand, color-match trip lever.</td> </tr> <tr> <td>3173RH</td> <td>Variation of model 3173, with right hand, color-match trip lever.</td> </tr> <tr> <td>3165</td> <td>Variation of model 3173, with cover lock.</td> </tr> <tr> <td>3174</td> <td>Variation of model 3173, with tank liner.</td> </tr> <tr> <td>3120</td> <td>Variation of model 3173, with left hand, chrome trip lever.</td> </tr> </tbody> </table>	3173	Standard 1.28 gpf configuration: 3-2" hybrid flapper flush valve, Fluidmaster <sup>®</sup> anti-siphon pilot fill valve, left hand, color-match trip lever.	3173RH	Variation of model 3173, with right hand, color-match trip lever.	3165	Variation of model 3173, with cover lock.	3174	Variation of model 3173, with tank liner.	3120	Variation of model 3173, with left hand, chrome trip lever.	
3173	Standard 1.28 gpf configuration: 3-2" hybrid flapper flush valve, Fluidmaster <sup>®</sup> anti-siphon pilot fill valve, left hand, color-match trip lever.										
3173RH	Variation of model 3173, with right hand, color-match trip lever.										
3165	Variation of model 3173, with cover lock.										
3174	Variation of model 3173, with tank liner.										
3120	Variation of model 3173, with left hand, chrome trip lever.										

Fixture performance and specifications meet or exceed ASME A112.19.2/CSA B45.1 standards, and other state and local codes.

