

PACKAGE CONTENTS

PART	DESCRIPTION	QUANTITY		
		P400274	P400275	P400276
A	Fixture	1	1	1
B	Glass shade	3	5	9
C	Socket ring	3	5	9
D	Stem	1	1	1
E	Socket ring (for P400482, P400483, P400484)	3	5	9

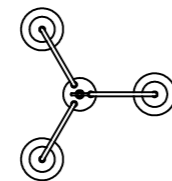

P400274
P400482 (Clear Glass)

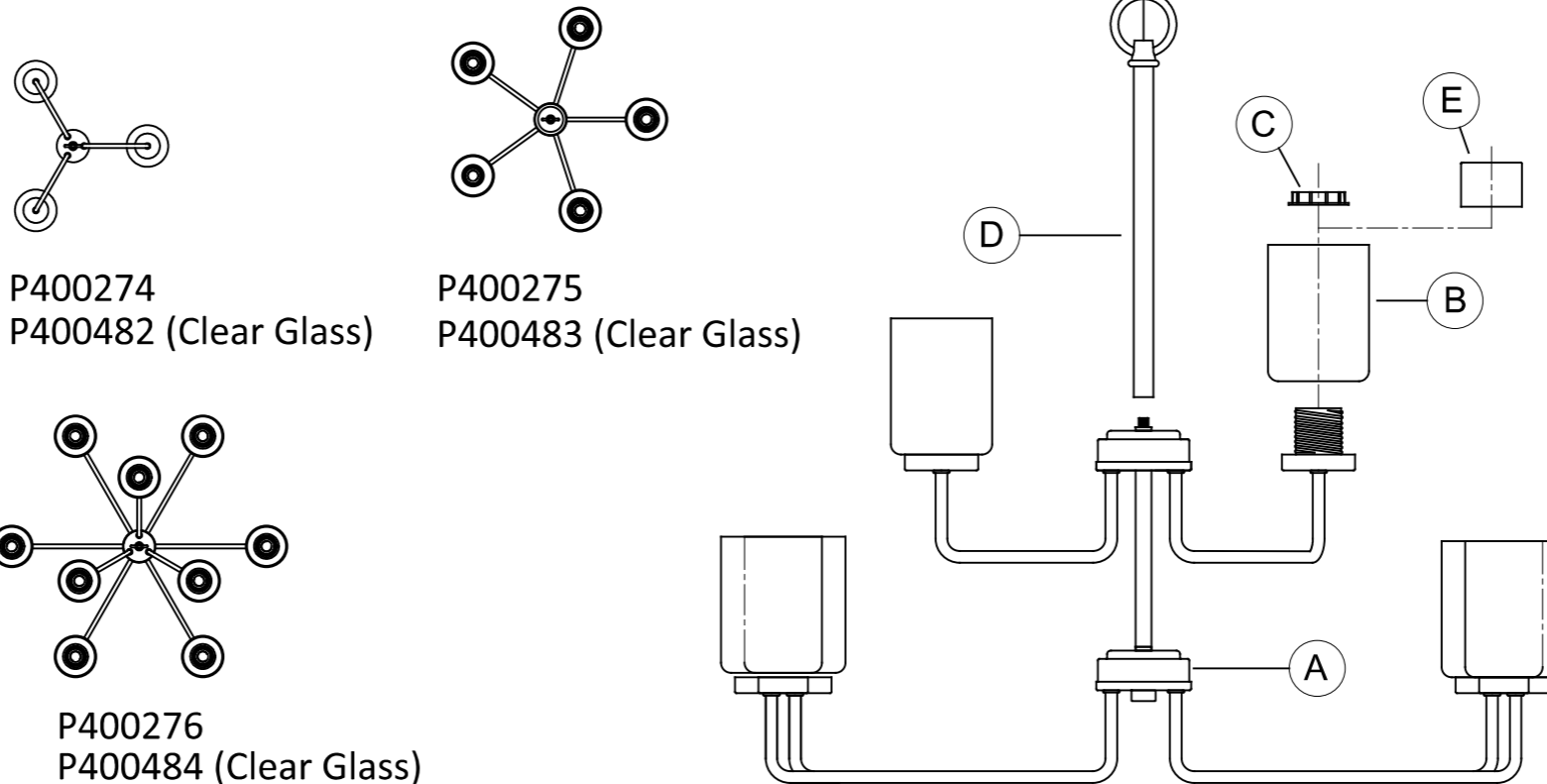
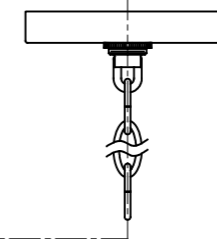
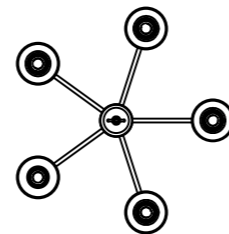

P400275
P400483 (Clear Glass)

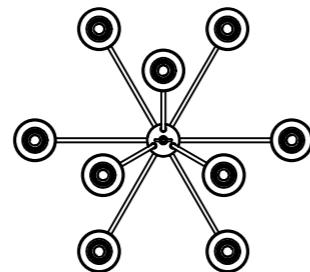

P400276
P400484 (Clear Glass)

HARDWARE CONTENTS (not actual size)

AA	BB	CC	DD	EE	FF	GG	HH
Hex nut	Wire nut	Mounting plate	Screw collar	Chain holder	Nipple	Chain	Canopy
Qty:2	Qty:3	Qty:1	Qty:1	Qty:1	Qty:1	Qty:1	Qty:1

THANK YOU for selecting Progress Lighting



We can assist you with questions regarding product information, assembly or missing parts





Safety Information

Please read and understand this entire manual before attempting to assemble, operate, or install the product.

CAUTION – RISK OF SHOCK:

Disconnect Power at the main circuit breaker panel or main fusebox before starting and during the installation.

WARNING:

This fixture is intended for installation in accordance with the National Electrical Code (NEC) and all local code specifications. If you are not familiar with code requirements, installation by a certified electrician is recommended. Failure to adhere to these codes and instructions may result in serious injury and/or property damage and will void the warranty.

CLEANING:

1. Always be certain that electric current is turned off before cleaning.
2. Only a soft damp cloth should be used. Harsh cleaning products may damage the finish.

Preparation

1. Before beginning installation, make sure all parts are included using the contents diagrams from page 1. If any part is missing or damaged, do not attempt to assemble, install or operate the product.
2. Estimated assembly time: 30 minutes.
3. Tools required for assembly (not included): Phillips screwdriver, pliers, wire stripper, safety glasses, electrical tape, ladder.

Care and Maintenance

Shut off main power supply before cleaning product or changing light bulbs. To clean, wipe with damp cloth. Do not use abrasive cleaners or cleaners that contain alcohol.

Assembly Instructions

1

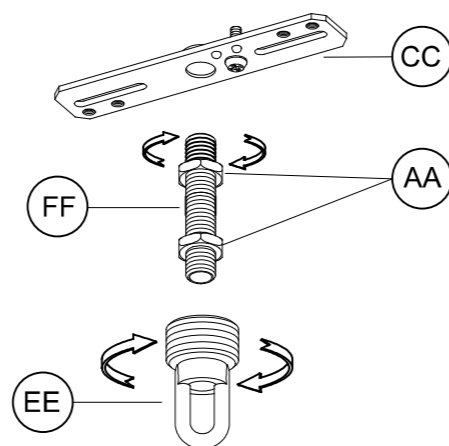

1. Screw threaded nipple (FF) into mounting plate (CC) several turns. Use one hex nut (AA) to secure parts tightly. Screw one hex nut (AA) and chain holder (EE) onto threaded nipple (FF). Tighten the hex nut against the top of the chain holder.

Hardware Used

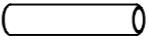
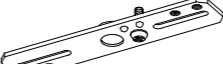
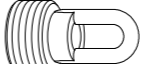
(AA)	Hex nut		X2
(FF)	Nipple		X1
(CC)	Mounting plate		X1
(EE)	Chain holder		X1

2

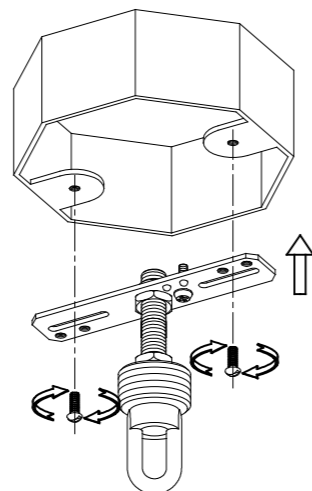

2. Attach assembled parts from Step 1 onto outlet box using the mounting screws supplied with the outlet box (not included).

ASSEMBLY INSTRUCTIONS

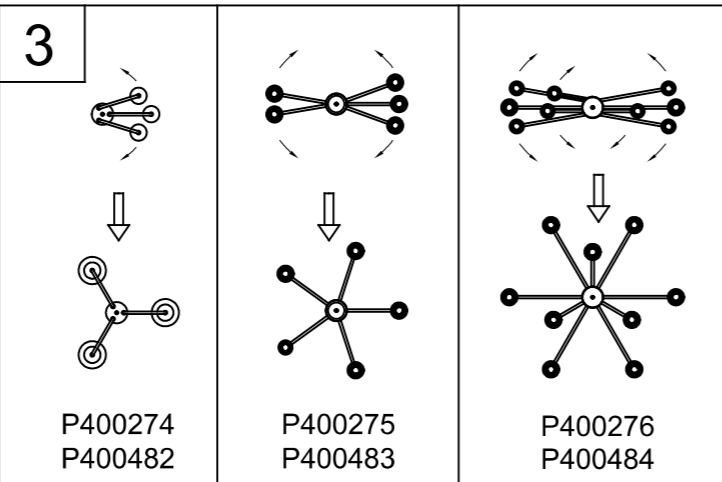

3. Equally adjust the arms by carefully turning them out from the center.

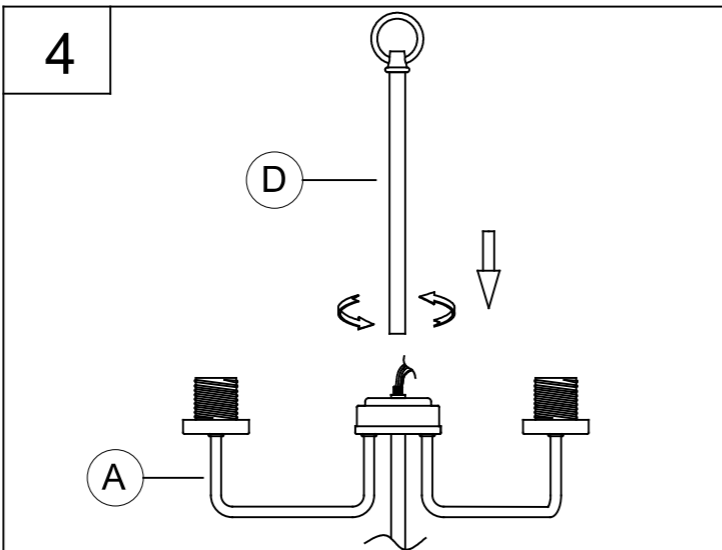

Note: Glass up center pipe assembly which is shown in Step 4 (P400275 & P400276 & P400484) is the same as glass down center pipe assembly (P400274).

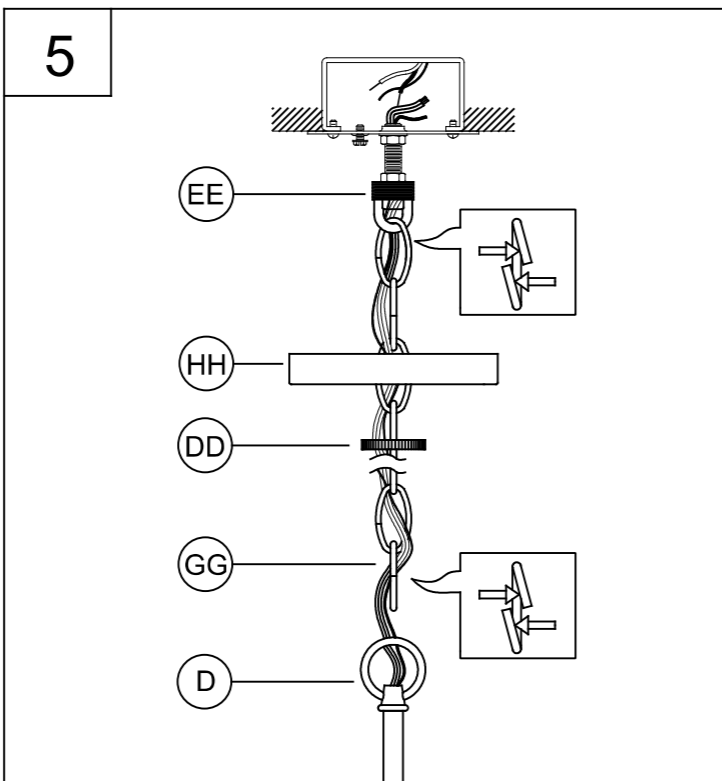

4. Pass the wires through the Chain loop of the stem (D). Attach stem (D) onto the nipple of the fixture (A) to secure tightly. As you do this, you will need to pull up the slack on the cord.



5. Weave wires through chain (GG). Pass wires and chain through screw collar (DD) and canopy (HH). Open two links of chain and attach one end to chain loop of the stem (D) and the other end to chain holder (EE). Close the chain links. Pass the wires through the chain holder/ threaded nipple/ mounting plate.

NOTE: During this step, you may choose to shorten the chain and electrical/ ground wires.

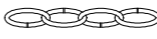
Hardware Used

(DD) Screw collar		X1
(GG) Chain		X1
(HH) Canopy		X1

ASSEMBLY INSTRUCTIONS

6

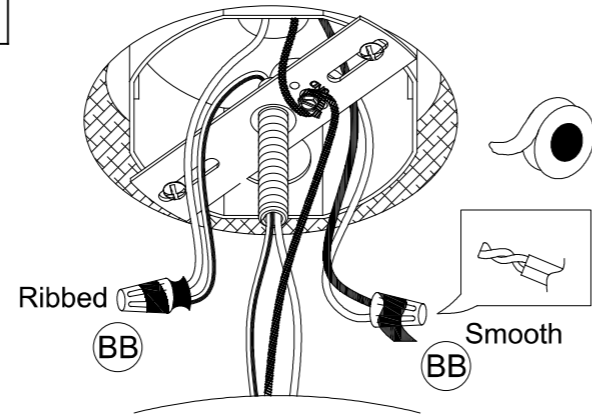

6. Strip 3/8" of insulation from the electrical wire ends. Using wire nuts (BB), connect RIBBED fixture wire to the WHITE supply wire from the outlet box; connect the SMOOTH fixture wire to the BLACK supply wire. Connect the fixture ground wire and supply ground wire using a wire nut or by fastening to the ground screw on the mounting plate. Push all wire connections into the outlet box.



7

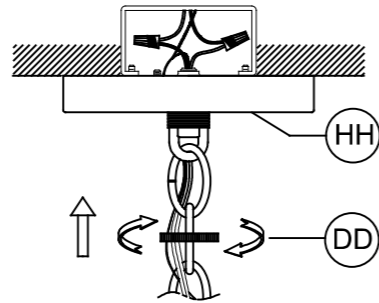

7. Tuck the wires into the outlet box and slip the canopy over the chain holder. Thread the screw collar (DD) onto the chain holder to secure the canopy tightly to the ceiling.

8

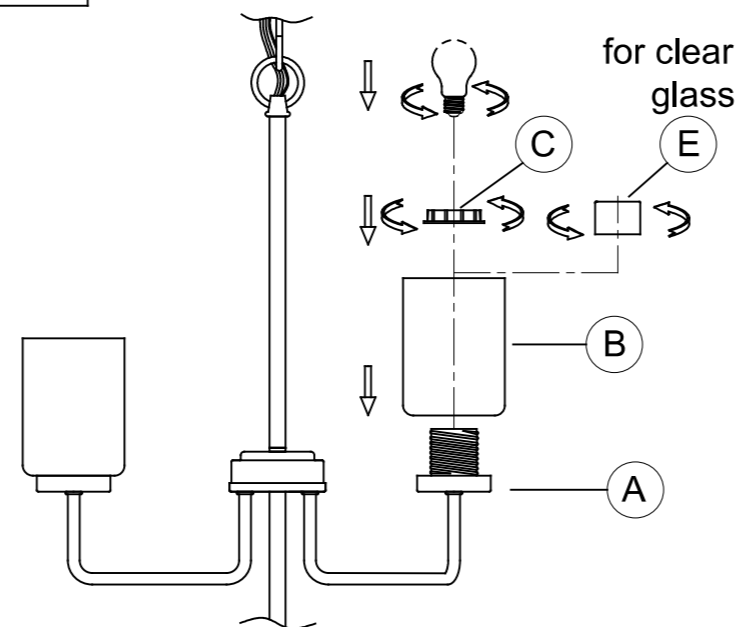

8. Place glass shades (B) and socket ring (C) onto fixture (A) to secure tightly.

NOTE: For P400482, P400483, P400484 clear glass shade, use socket ring (E) and tighten the glass shade (B) onto the fixture (A) socket.

Screw lamp (not included) into fixture socket. Use 100-watt MAX incandescent medium base lamp, SBCFL or SBLED.

Instructions d'Assemblage et Installation

Mise en garde: Lire les instructions avec soin et couper le courant au disjoncteur central avant de commencer l'installation.

Veillez lire et comprendre l'intégralité de ce manuel avant de tenter d'assembler, d'utiliser ou d'installer le produit.

ATTENTION - RISQUE DE DÉCHARGES ÉLECTRIQUES -

Couper le courant au niveau du panneau du disjoncteur du circuit principal ou de la boîte à fusibles principale avant de procéder à l'installation.

ATTENTION:

Ce luminaire doit être installé conformément aux codes d'électricité nationaux (NEC) et satisfaire toutes les spécifications des codes locaux. Si vous ne connaissez pas les exigences de ces codes, il est recommandé de confier l'installation à un électricien certifié. Ne pas se conformer à ces codes et directives pourrait provoquer des blessures sérieuses et/ou des dommages matériels et rendre la garantie non valide.

RÉGLAGE DE L'INTENSITÉ:

Ce luminaire à DEL est compatible avec la plupart des régulateurs d'intensité pour ampoules incandescentes, régulateurs d'intensité pour DEL, et régulateurs d'intensité électroniques basse tension. Pour une performance optimale, un régulateur d'intensité électronique basse tension devrait être utilisé.

Consulter progresslighting.com pour obtenir une liste de gradateurs compatibles.

NETTOYAGE:

- Soyez toujours certain que l'alimentation électrique du luminaire est fermée avant le nettoyage.
- N'utilisez qu'un chiffon doux humide. Les produits de nettoyage acides/abrasifs peuvent endommager le fini.

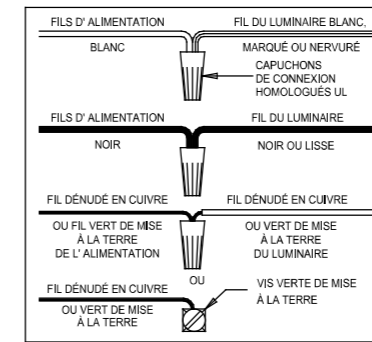

Instrucciones de ensamblaje e instalación

Precaución: Lea cuidadosamente las instrucciones y desconecte la electricidad del cortacircuitos principal antes de iniciar la instalación.

Por favor, lea y comprenda todo este manual antes de intentar ensamblar, operar o instalar el producto.

PRECAUCIÓN - RIESGO DE DESCARGA ELÉCTRICA:

Desconecte la electricidad en el panel principal del interruptor automático o caja principal de fusibles antes de comenzar y durante la instalación.

ADVERTENCIA:

Este accesorio está destinado a la instalación de acuerdo con el National Electrical Code (NEC) y todas las especificaciones del código local. Si no está familiarizado con los requisitos del código, la instalación se recomienda un electricista certificado. No cumplir con estos códigos e instrucciones puede resultar en lesiones graves y/ o en daños a la propiedad y anulará la garantía.

REGULACIÓN DE INTENSIDAD DE LUZ:

Este artefacto LED es compatible con la mayoría de los reguladores de intensidad incandescentes estándares, los reguladores de intensidad LED, y los reguladores de intensidad de bajo voltaje electrónicos. Para un desempeño óptimo, debería usarse un regulador de intensidad de bajo voltaje electrónico.

Consulte progresslighting.com para ver una lista de atenuadores compatibles.

LIMPIEZA:

- Asegúrese siempre de que la corriente eléctrica esté apagada antes de limpiar.
- Debe usarse solamente un paño húmedo y suave. Productos de limpieza abrasivos pueden dañar el acabado.

