

2018HBNS GRANDE ISLE™



Wall-Mount, ADA*, Vitreous China Lavatory

FEATURES



- 22" x 18-1/8" commercial wall-mount lavatory with back splash
- 16" x 10-5/8" basin
- Concealed front overflow
- Complies with ADA requirements for accessibility
- Drilled for concealed arm carrier, required
- Available in single hole, 4" and 8" faucet centers
- Mansfield® limited lifetime warranty
- Available in White

*This product is designed to meet ADA requirements when properly installed in accordance with ADA guidelines.



MODEL 2018HBNS

COMPONENTS



MODEL #	DESCRIPTION	CODES/STANDARDS
2018HBNS-1 <small>(201810001)</small>	Commercial wall-mount lavatory with backsplash and single hole faucet center. Does not include faucet, drain assembly and supply.	 
2018HBNS-4 <small>(202110001)</small>	Same as above with 4" faucet center.	
2018HBNS-8 <small>(202210001)</small>	Same as above with 8" faucet center.	

2018HBNS GRANDE ISLE™



Wall-Mount, ADA*, Vitreous China Lavatory

SPECIFICATIONS

MODEL #	DESCRIPTION	CODES/STANDARDS
2018HBNS	Wall-mount, vitreous china lavatory	 

MATERIAL	Vitreous China
WARRANTY	Vitreous China - Limited Lifetime

SHIPPING WEIGHT	Model 2018HBNS - 37 lbs. (17 kg)
FAUCET HOLES	Single hole, 4" or 8"

TECHNICAL INFORMATION

Note: these dimensions are nominal and subject to change without notice.

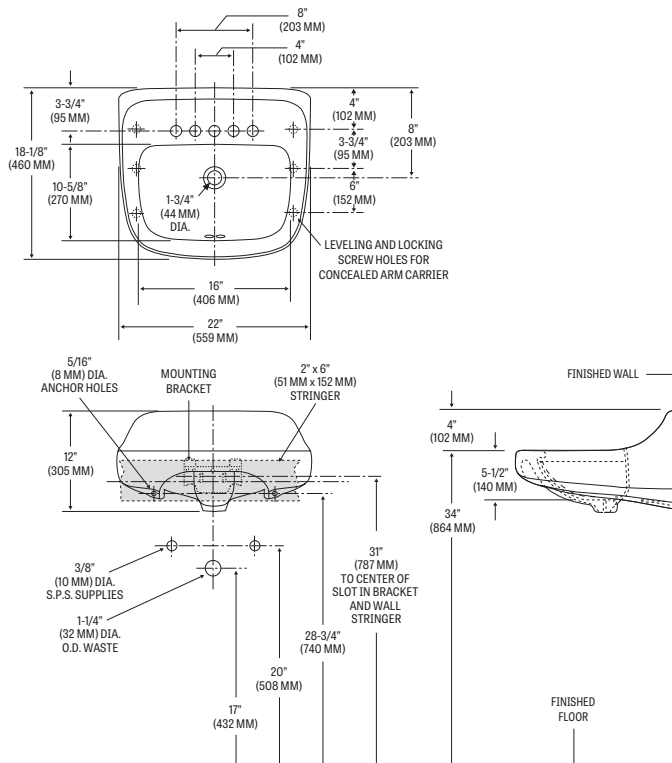
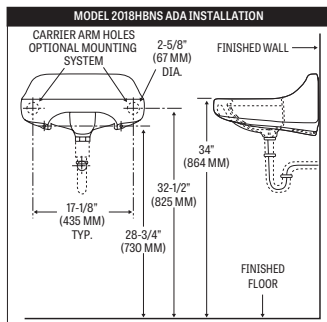

 All Mansfield® wall-mount lavatories are supplied with this exclusive one-piece steel hanger. Easily installed and adjusted, it contains 7 holes for solid mounting against wall. Anchoring screw must be used for correct installation. Standard plumbing practice recommends use of both mounting brackets and anchoring screws.

NOTE: For secure installation, wall-mounting hanger should be fastened to solid support wall stud.

Fixture performance and specifications meet or exceed ASME A112.19.2/CSA B45.1 standards, and other state and local codes.