

# 147-155 QUANTUM® 1.28

**MANSFIELD®**

Elongated Front, Vitreous China, Two-Piece Toilet

## FEATURES

- High performance, pressure-assist Flushmate™ system
- 1.28 gpf / 4.86 lpf low water consumption
- Elongated front bowl
- 12" rough-in
- Model 45 chrome-plated, metal trip lever
- 2" glazed trapway
- The Mansfield® Limited Lifetime Warranty  
Flushmate five-year limited warranty on vessel
- Available in white





**MODEL 147-155**

Toilet seat not included



ELONGATED

## COMPONENTS



MODEL #	DESCRIPTION	CODES/STANDARDS
147-155	Elongated front, pressure-assist, two-piece toilet. Less toilet seat and supply.	  
147	Elongated front, pressure-assist bowl only. Less toilet seat and supply.	
155	Pressure-assist tank and cover only with left hand chrome-plated, metal trip lever. Less supply.	
<b>TANK OPTIONS</b>		
155RH	Pressure-assist tank and cover only with right hand chrome-plated, metal trip lever. Less supply.	
<b>TANK TRIM &amp; REPLACEMENT PARTS</b>		
45	Trip lever - chrome-plated, metal trip lever, left hand	
FLUSHMATE® 503	Pressure-assist flushing system. Separate warranty applies. Contact FLUSHMATE® at 1-800-533-3460.	

# 147-155 QUANTUM® 1.28



Elongated Front, Vitreous China, Two-Piece Toilet

## SPECIFICATIONS

MODEL #	DESCRIPTION	CODES/STANDARDS
147-155	Elongated front (1.28 gpf/4.86 lpf) two-piece toilet	  

MATERIAL	Vitreous China
WATER PRESSURE RANGE	35 to 80 PSI
FLUSH SYSTEM	Flushmate™ flushing technology
WATER USAGE	1.28 gpf / 4.86 lpf
WATER SURFACE AREA	8-3/4' X 10-3/8'
ROUGH-IN	12'
MAP RATING	Pending

TRAP DIAMETER	2'
TRAP SEAL	2-1/4'
SHIPPING WEIGHT	Model 147 - 50 lbs. (22 kg) Model 155 - 43 lbs. (19.5 kg)
WARRANTY	Vitreous China - Limited Lifetime Vessel - Limited Five-Year (Flushmate)

## TECHNICAL INFORMATION

**Note:** these dimensions are nominal and subject to change without notice.

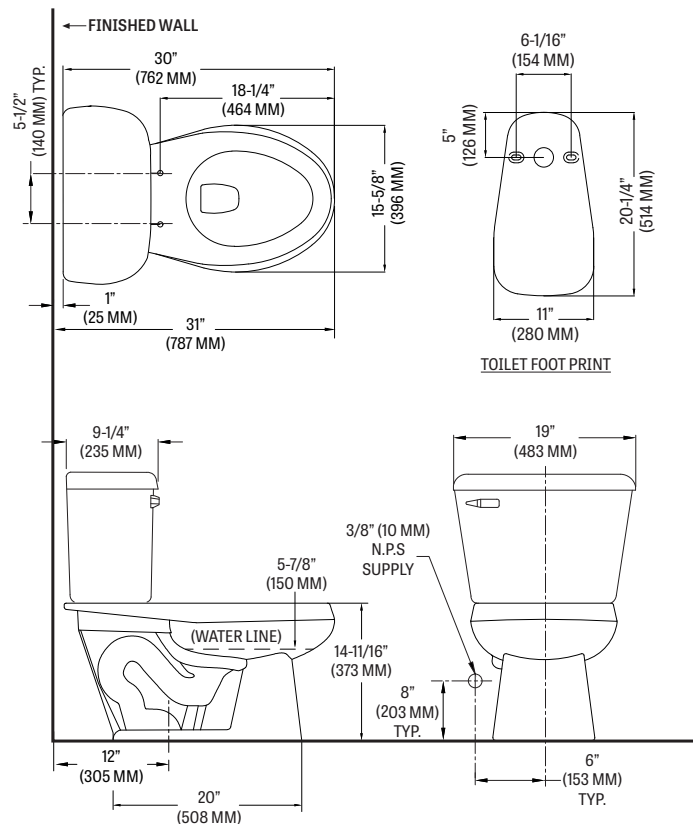

Fixture performance and specifications meet or exceed ASME A112.19.2-2013/CSA B45.1-13 standards, and other state and local codes.