

PACKAGE CONTENTS

| PART | DESCRIPTION | QUANTITY | | | |
|------|-------------------|----------|---------|---------|---------|
| | | P400457 | P400458 | P400459 | P400460 |
| A | Fixture | 1 | 1 | 1 | 1 |
| B | Decorative Column | 1 | 1 | 1 | 1 |
| C | Stem | 1 | 1 | 1 | 1 |

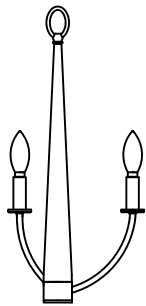

P400457

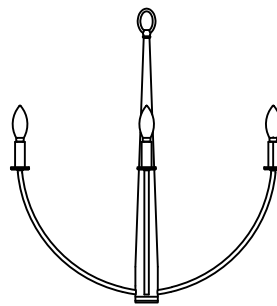

P400458

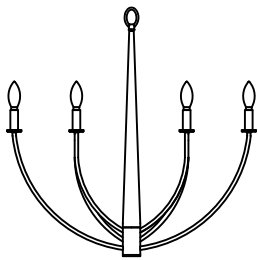

P400459

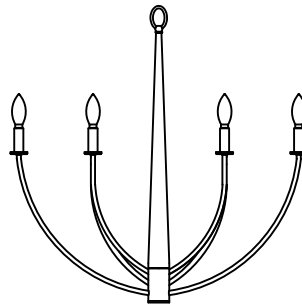

P400460

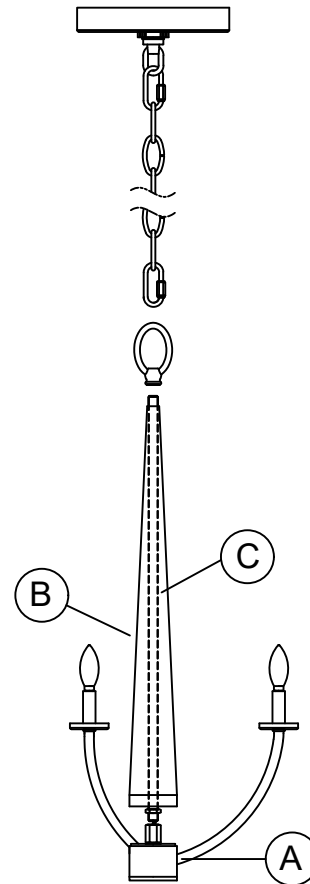

HARDWARE CONTENTS (not actual size)

| | | | | | | | | | | |
|---------|----------------|----------------|--------------|--------------|--------|-------|--------|------------|-----------------|------------|
| AA | BB | CC | DD | EE | FF | GG | HH | JJ | KK | LL |
| | | | | | | | | | | |
| Hex Nut | Wire Connector | Mounting Strap | Screw Collar | Chain Holder | Nipple | Chain | Canopy | Quick link | Mounting Screws | Chain Loop |
| Qty:3 | Qty:3 | Qty:1 | Qty:1 | Qty:1 | Qty:1 | Qty:1 | Qty:1 | Qty:2 | Qty:2 | Qty:1 |

THANK YOU for selecting Progress Lighting



We can assist you with questions regarding product information, assembly or missing parts



800-447-0573

8am-8pm (Eastern), Monday-Friday



customerservice@progresslighting.com



Safety Information

Please read and understand this entire manual before attempting to assemble, operate or install the product.

CAUTION: Read instructions carefully and turn electricity off at main circuit breaker panel before beginning installation.

CAUTION: Risk of fire. Min. 90°C supply conductors. Consult a qualified electrician to ensure correct branch circuit conductor.

WARNING: If any Special Control Devices are used with this fixture, follow instructions carefully to assure full compliance with N.E.C. requirements. If there are any questions, contact a qualified electrical contractor.

CAUTION: All glass is fragile. Use care when handling glass shades and bulbs.

Preparation

1. Before beginning installation, make sure all parts are included using the contents diagrams from page 1. If any part is missing or damaged, do not attempt to assemble, install or operate the product.

2. Estimated assembly time: 30 minutes.

3. Tools required for assembly (not included): Phillips screwdriver, pliers, wire stripper, safety glasses, electrical tape, ladder.

Care and Maintenance

Shut off main power supply before cleaning product or changing light bulbs. To clean, wipe with damp cloth. Do not use abrasive cleaners or cleaners that contain alcohol.

Assembly Instructions

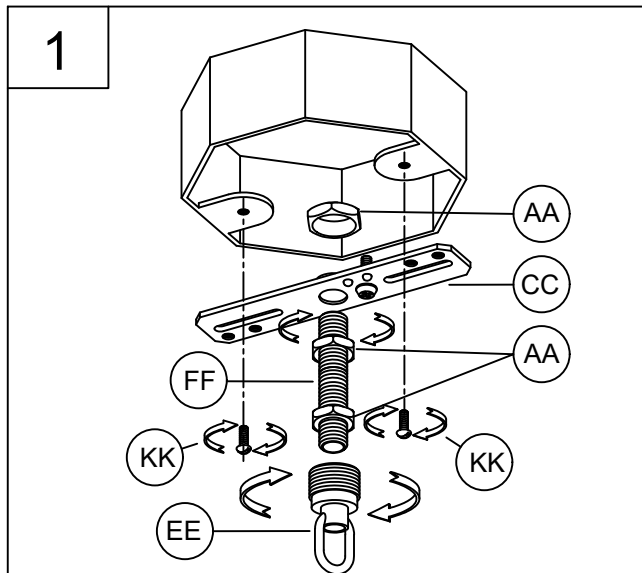

1. Screw nipple (FF) into chain holder (EE) a minimum of 6 mm (1/4"). Lock into place with hex nut (AA). Run another hex nut down nipple. Screw nipple (FF) into mounting strap (CC). Mounting strap must be positioned with extruded thread facing into outlet box. Screw third hex nut onto end of threaded pipe protruding from back of mounting strap.

Attach the mounting strap (CC) assembly to the outlet box (not provided) using the mounting screws (KK). Tighten securely.

2. In this step, you will adjust the depth of the chain holder in relation to the canopy depth.

Take the canopy (HH) and slip it over the chain holder (EE). You will need to adjust the chain holder so at least 1/4" of the threaded portion is exposed through the canopy hole. This is done by adjusting the depth of the nipple (FF) on the mounting strap (CC). When the chain holder (EE) is correctly adjusted, remove the canopy (HH) and tighten the top two hex nut (AA) against the mounting strap (CC) and the bottom hex nut (AA) against the chain holder (EE).

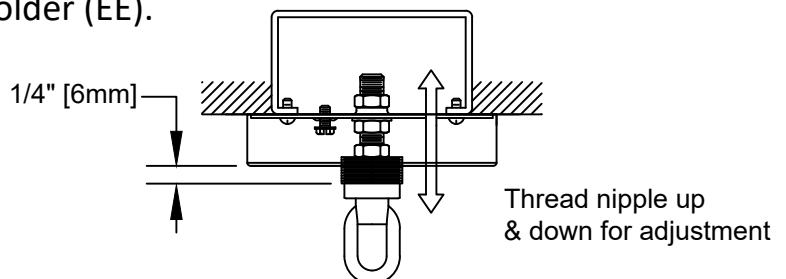
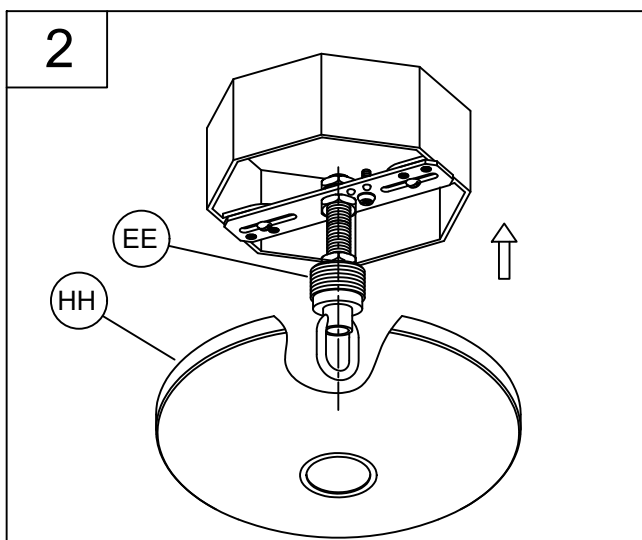

ASSEMBLY INSTRUCTIONS

3

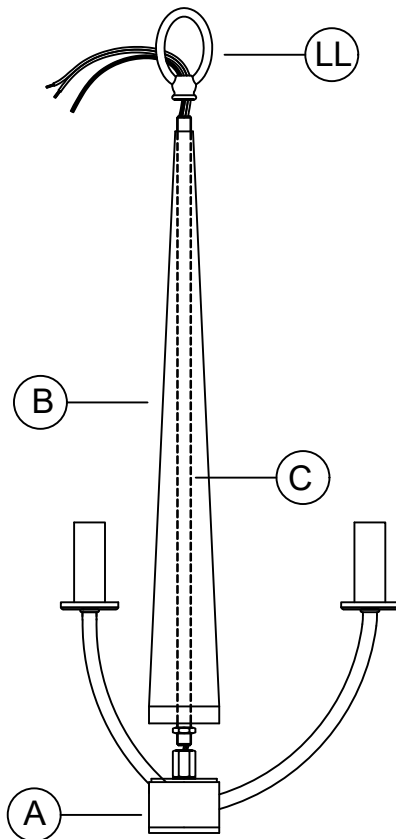

3. Pass the wires through the stem (C), decorative column (B) and chain loop (LL).

Tighten the stem (C) into the fixture (A), attach the decorative column (B) onto the fixture in place, then tighten the chain loop (LL) to secure them.

4

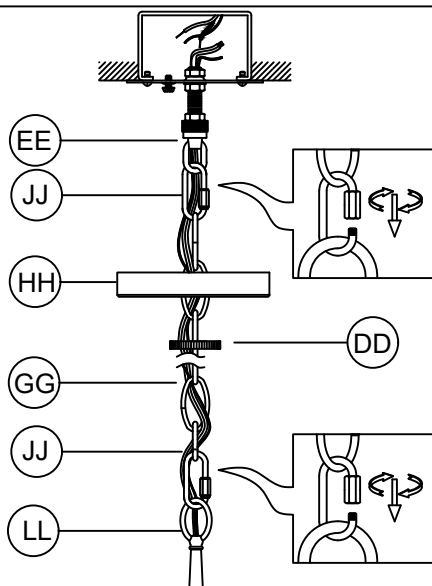

NOTE: During this step, determine the hanging length of your fixture by removing chain links (GG) and optionally cutting the electrical and ground wire to length.

Do NOT cut electrical or ground wires until this overall length is determined. Leave **AT LEAST 6 inches MINIMUM** of wire past the chain holder (EE) to allow for easy connections in step 5.

4. Once hanging length is determined. Open the quick links (JJ). Attach one open quick link (JJ) to chain loop (LL) and to one end of chain (GG). Close the quick link by threading the nut down onto the link end, pass the screw collar (DD) and the canopy (HH) onto the chain (GG). Attach second open quick link to other end of chain (GG) and to chain holder (EE). Close the quick link by threading the nut down onto the link end.

You can now weave the fixture wires through every third chain link (GG). Continue to pass the wires through the screw collar (DD), canopy (HH) and the chain holder (EE) and up into the outlet box.

ASSEMBLY INSTRUCTIONS

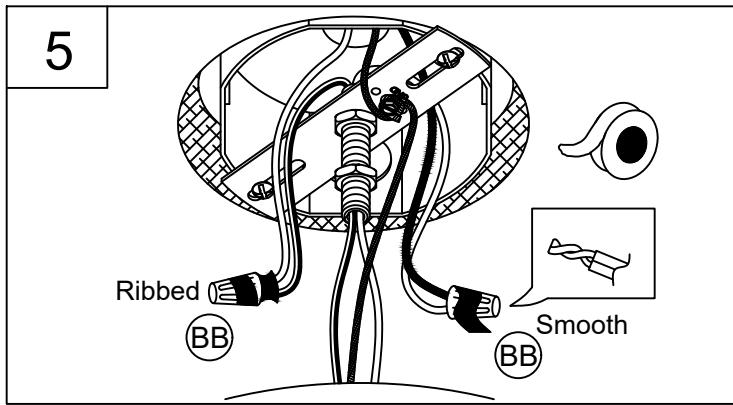

5. Strip 3/8" of insulation from the electrical wire ends. Using wire connectors (BB), connect the RIBBED fixture wire to the WHITE supply wire from the outlet box; connect the SMOOTH fixture wire to the BLACK supply wire from the outlet box. Connect the fixture ground wire and supply ground wire using a wire connector or by fastening it to the ground screw on the mounting strap. Push all wire connections into the outlet box.

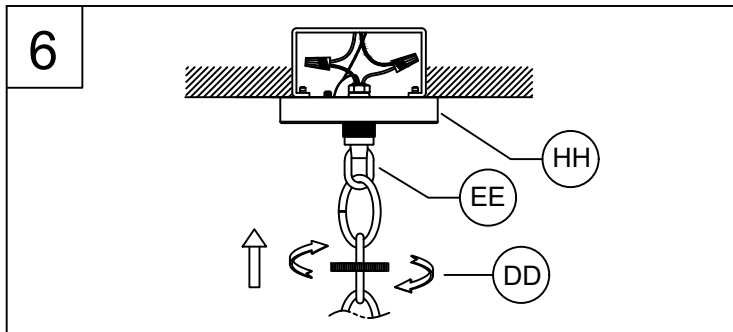

6. Tuck the wires into the outlet box and slip the canopy (HH) over the chain holder (EE). Thread the screw collar (DD) onto the chain holder to secure the canopy tightly to the ceiling.

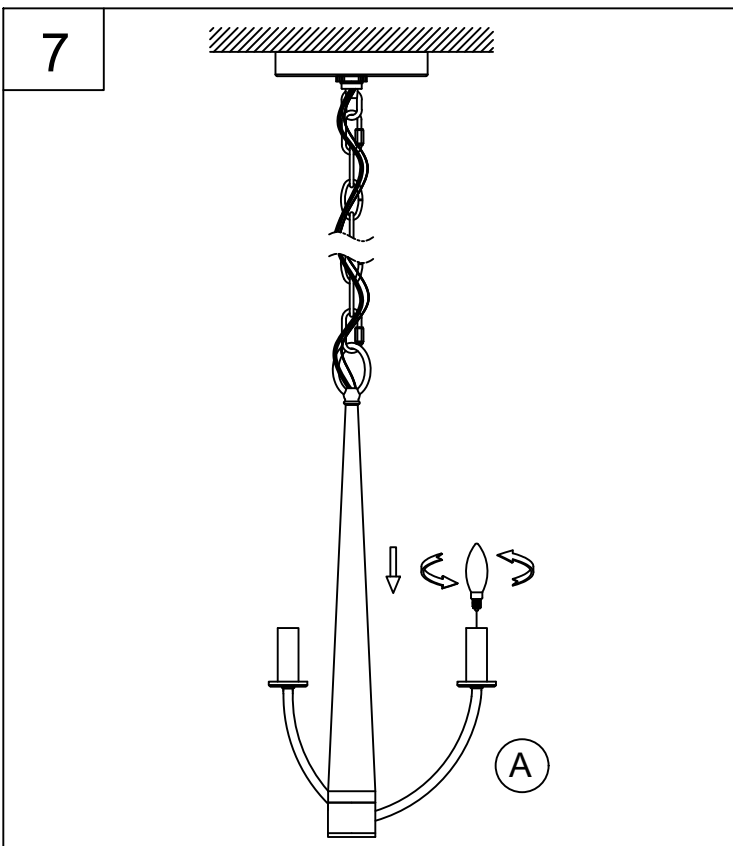

7. Thread the lamps (not included) into the fixture sockets and secure it tightly.

Use 60-watt MAX incandescent candelabra base, SBCFL or SBLED.

WARRANTY AND EXCLUSIVE REMEDY: Progress products, when properly installed and under normal conditions of use, are warranted to our customers only to be free from defects in material and workmanship at time of shipment. All warranty claims must be asserted within one year from date of purchase of the subject items; thereafter, warranty claims will not be honored. Customers' sole remedy for a warranty claim or otherwise shall be limited to repair or replacement of the subject product if it is shown to have been defective in material or workmanship at time of shipment. Progress's sole and maximum liability for a defective product shall never exceed the cost of the subject product. **EXCEPT FOR SUCH A WARRANTY AND EXCLUSIVE REMEDY AS STATED (AND THE EXPRESS WARRANTY OF TITLE), WE DISCLAIM ALL OTHER WARRANTIES, WHETHER EXPRESS OR IMPLIED, AND SPECIFICALLY DISCLAIM THE IMPLIED WARRANTIES OF MERCHANTABILITY AND FITNESS FOR A PARTICULAR PURPOSE. IN NO EVENT SHALL WE BE LIABLE TO CUSTOMER IN WARRANTY, CONTRACT, NEGLIGENCE, STRICT LIABILITY OR OTHERWISE, FOR ANY DAMAGES, WHETHER INCIDENTAL OR CONSEQUENTIAL, WHICH ARE ALLEGED TO BE CAUSED BY ONE OR MORE OF OUR PRODUCTS, BEYOND THE COST TO THE CUSTOMER OF THE SUBJECT PRODUCT OR PRODUCTS.** Therefore, the customer's sole and exclusive remedy against us for breach of the warranty, breach of contract or negligence or strict liability or otherwise shall be limited to repair or replacement of the subject product at our option (excluding installation and removal charges which shall not be our liability) or, if we choose, refund of the purchase price. In no case does our warranty and exclusive remedy extend to anybody other than our customers. Our customers are not authorized to extend warranties or remedies on our behalf to anyone. Such unauthorized extensions of warranties or remedies by the customer shall remain customer's responsibility. Customer is responsible for determining the suitability of our products for customer's use or resale, or for incorporating them into objects or for applications which customer designs, assembles, constructs or manufactures.

Instructions d'Assemblage et Installation

Mise en garde: Lire les instructions avec soin et couper le courant au disjoncteur central avant de commencer l'installation.

MISE EN GARDE: Lire les instructions avec soin et couper le courant au disjoncteur central avant de commencer l'installation.

MISE EN GARDE: Risque d'incendie. Min 90°C conducteurs d'alimentation. Consulter un électricien qualifié pour assurer le bon conducteur de circuit de dérivation.

AVERTISSEMENT - S'il y a d'autres mécanismes régulateurs qui s'emploient avec ce dispositif, suivre soigneusement les instructions pour satisfaire aux exigences NEC. Si vous avez des questions, consulter un électricien qualifié.

MISE EN GARDE - Le verre est toujours fragile; maniez le(s) composant(s) et/ou l' (les) ampoule(s) avec prudence.

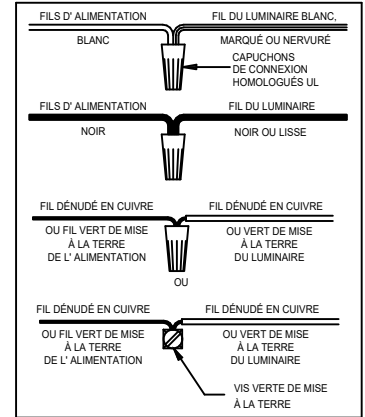

Instrucciones de ensamblaje e instalación

Precaución: Lea cuidadosamente las instrucciones y desconecte la electricidad del cortacircuitos principal antes de iniciar la instalación.

PRECAUCIÓN: Lea cuidadosamente las instrucciones y desconecte la electricidad del cortacircuitos principal antes de iniciar la instalación.

PRECAUCIÓN: Riesgo de fuego. Min. 90°C los cables de suministro. Consulte a un electricista calificado para asegurarse de que el conductor del circuito derivado correcto.

ADVERTENCIA - Si usa algún dispositivo especial de control con este aparato de luz, siga las instrucciones cuidadosamente para asegurar la completa conformidad con los requisitos N.E.C. Si existe alguna duda, contacte un electricista calificado.

PRECAUCION - El vidrio es frágil; tenga cuidado al manipular el (los) elemento(s) de vidrio y/o la(s) bombilla(s).

