

5473

MANSFIELD®

Brentwood™ 66" x 36" x 22 1/2"

Swirl-way® Combination Whirlpool and Air Massage Bath

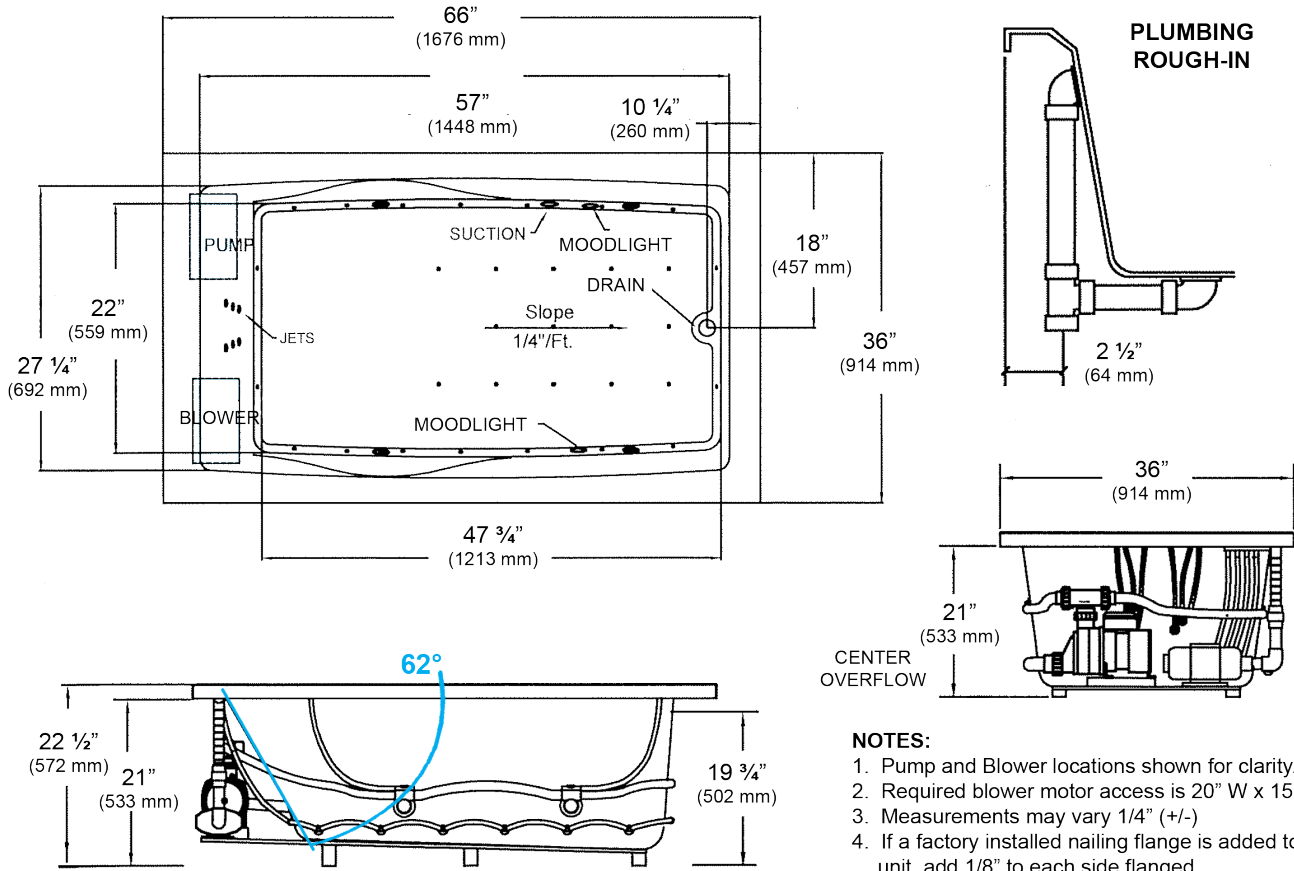

- NOTES:**
1. Pump and Blower locations shown for clarity.
 2. Required blower motor access is 20" W x 15" H.
 3. Measurements may vary 1/4" (+/-)
 4. If a factory installed nailing flange is added to a unit, add 1/8" to each side flanged.
 5. Removable apron is not available for this unit.
 6. These dimensions are nominal and subject to change without notice.

SPECIFICATIONS

Specification	Description	Specification	Description
Material	Acrylic, fiberglass reinforced	Number of Jets	WP - 14 Air - 30
Construction	Self-contained, pre-plumbed air bath system mounted on a pre-leveled base	Water Capacity	60 gal. (min) 75 gal. (max)
Pump/Blower Motor	Pump - 1.0 HP Single Speed - 120 V, 9.0 AMP Blower - 1.0 HP Variable Speed - 120 V, 9.0 AMP	Floor Loading Weight	47 lbs. / sq. ft (229 kg/m ²)
Electrical Requirements	Three 120V, 20 AMP, GFCI Protected Circuits	Shipping Weight	165 lbs.
On/Off Control	Eight button electronic control, 20 minute time cycle; Blower - Auto purge cycle	Warranty	Limited Ten Year

