

475HE SUBURBAN™





Integral Trap, Siphon Jet, Vitreous China Urinal

FEATURES

- Siphon jet, high efficiency urinal
- Integral trap
- 0.5 gpf / 1.9 lpf
- Complete with 3/4" top spud
- 14-5/8" x 21-3/8" x 14-3/8"
- Complies with ADA requirements for accessibility
- The Mansfield® limited lifetime warranty
- Available in White



COMPONENTS

MODEL #	DESCRIPTION	CODES/STANDARDS
475HE	Vitreous china integral trap, siphon jet urinal. Complete with 3/4" top spud, 2" IPS outlet connector and gaskets. Concealed mounting bracket, bolts and washers. Less flushometer.	  
PARTS & ACCESSORIES		
471-3261	Urinal hanger	
531-0016	Rear outlet urinal spud kit - 1-1/2" cast brass top urinal spud	
24	Urinal top spud - 1" x 3/4" cast brass top urinal spud	





475HE SUBURBAN™



Integral Trap, Siphon Jet, Vitreous China Urinal

SPECIFICATIONS

MODEL #	DESCRIPTION	CODES/STANDARDS
475HE	Integral trap, siphon jet Urinal	  

MATERIAL	Vitreous China
WATER USAGE	0.5 gpf / 1.9 lpf
INLET	3/4"
OUTLET	2"
ROUGH-IN	Wall-mount

SHIPPING WEIGHT	Model 475HE - 35 lbs. (16 kg)
WARRANTY	Vitreous China - Limited Lifetime Tank Trim - Limited One Year

TECHNICAL INFORMATION

Note: these dimensions are nominal and subject to change without notice.

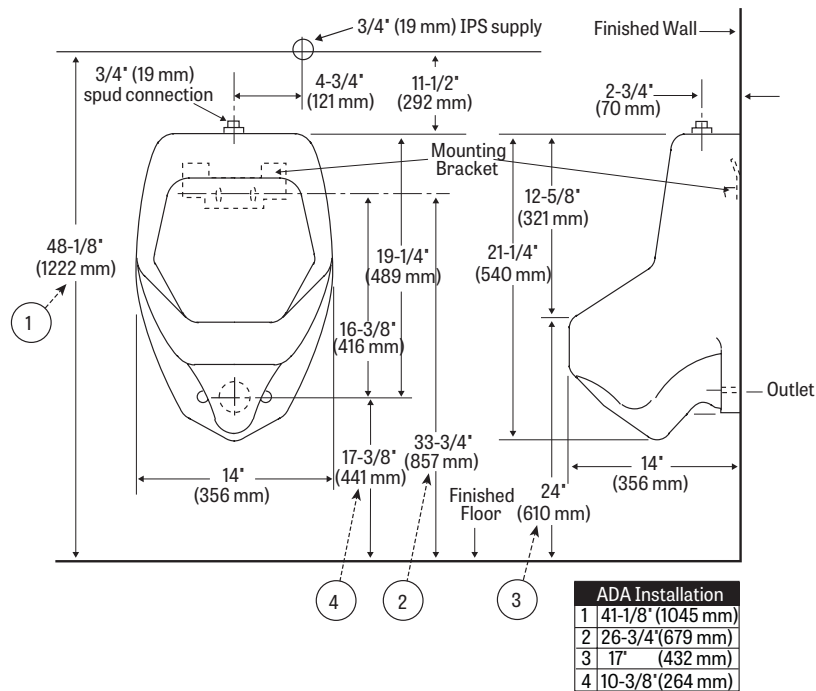

All Mansfield wall-mounted urinals are supplied with this exclusive one-piece steel hanger. Easily installed and adjusted it contains 7 holes for solid mounting against wall. Anchoring screws must be used for correct installation. Standard plumbing practice recommends use of both mounting bracket and anchoring screws. NOTE: For secure installation, wall mounting hanger should be fastened to solid, support wall stud.

Fixture performance and specifications meet or exceed ASME A112.19.2-2013/CSA B45.1-13 standards, and other state and local codes.

