

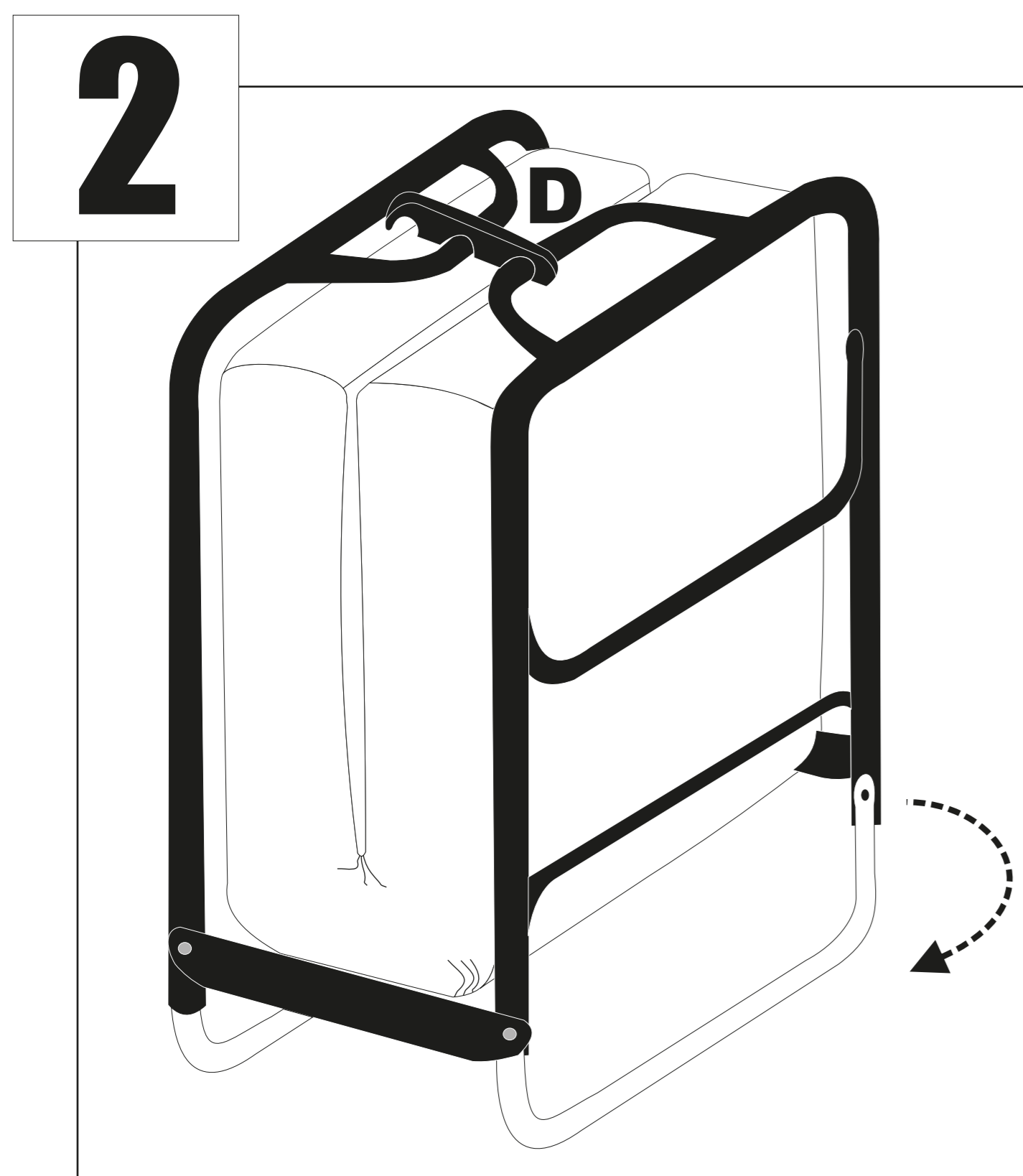

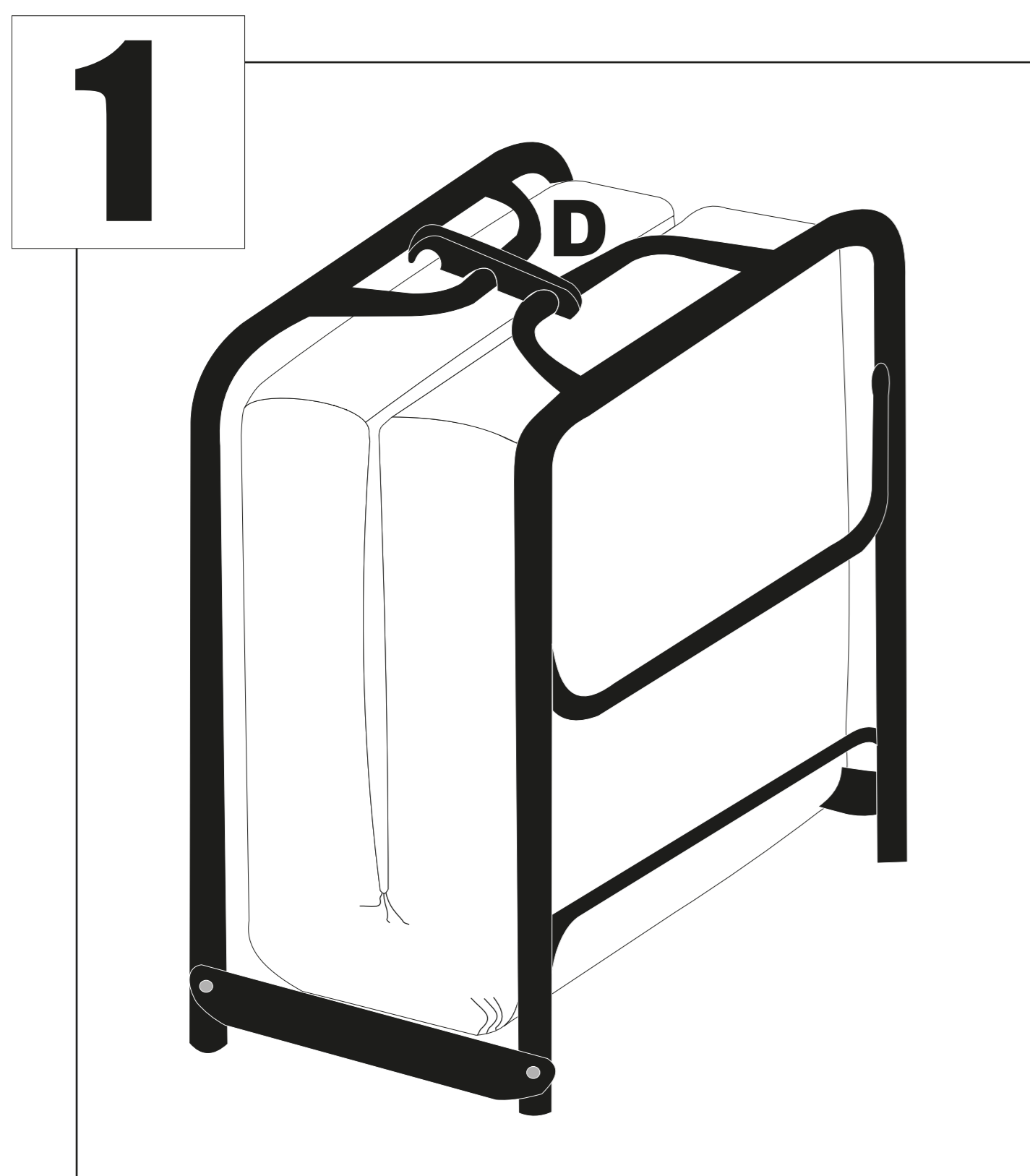

# ASSEMBLY INSTRUCTIONS

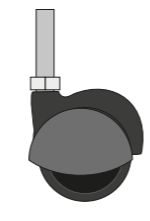
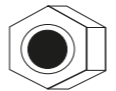

Contents			
<b>A</b>		<b>x 4</b>	
<b>B</b>		<b>x 4</b>	
<b>C</b>		<b>x 4</b>	
<b>D</b>		<b>x 1</b>	Do not use
		<b>x 2</b>	

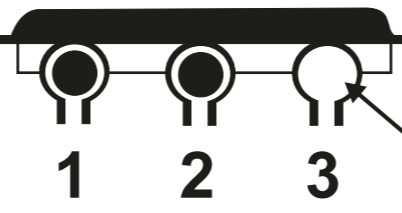

- 1) Carefully remove plastic wrap and cardboard packing and cut plastic band.
- 2) Open bed and remove parts for assembly.
- 3) Close bed and snap clip-lock bar using slots (1) and (2) as shown in illustration. Do not use slot (3).
- 4) Lay folded bed on one side (See picture n°1)
- 5) Open two center legs (See picture n°2)
- 6) Place the flat side (top) of the leg cross-bar against the bottom of the central leg, align holes, insert caster (A) into hole and secure using nut (B). Repeat with remaining three casters (See picture n°3)
- 7) Stand bed upright and insert the four plastic leg caps (C) by inserting the center tabs into the holes on the outside legs (See picture n°4)

## TO USE BED:

**ATTENTION: remove plastic wrap from mattress before use.**

- 1) Unfold legs by pulling each leg upward until it is perpendicular to side of folded bed.
- 2) Release the Clip-Lock Bar on top of folded bed by grasping finger hold at one end and pulling upward. When Clip-Lock Bar releases, lower one side of the bed until leg rests on floor. Then, lower opposite side of bed until leg rests on floor and bed is fully opened.

**NOTE: AS CLIP-LOCK IS RELEASED. HOLD HANDLES ON TOP OF BED TO PREVENT BED FROM OPENING TOO RAPIDLY.**

- 3) After use, fold bed and secure with Clip-Lock Bar for easy storage.