

5273

MANSFIELD®

Brentwood™ 66" x 36" x 22 1/2"

Swirl-way® MicroDerm™ Therapeutic Bath

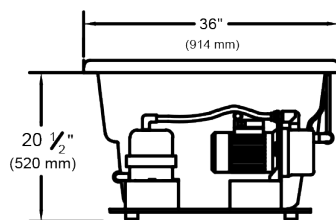
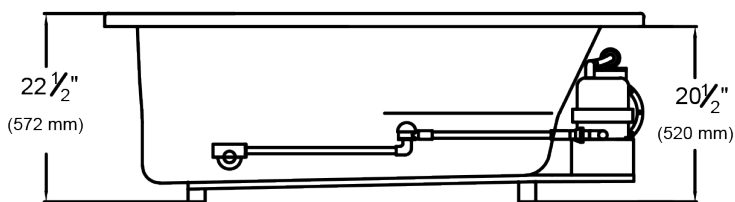
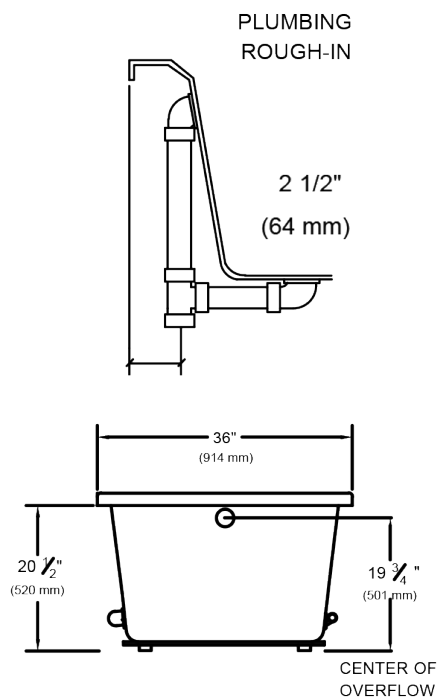
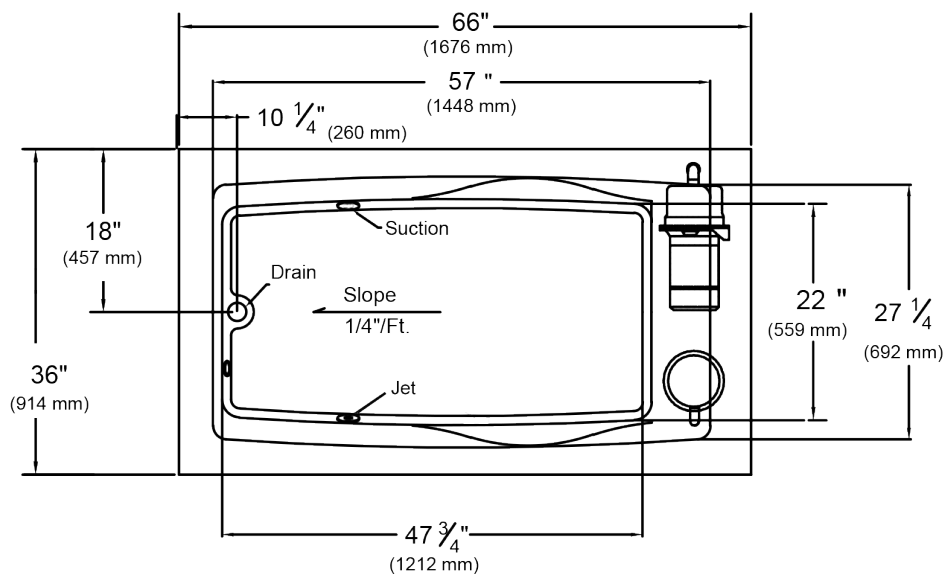

Rough-in measurements may vary 1/4" (+/-)
These dimensions are nominal and subject to change without notice

SPECIFICATIONS

Specification	Description	Specification	Description
Construction	Self-contained, pre-plumbed bath system mounted on a pre-leveled base	Water Capacity	60 gal. (min) 75 gal. (max)
Number of Ports	1	Shipping Weight	165 lbs.
Pump Motor	120V, 10 Amp, 60 Hz; Thermally protected	Floor Loading Weight	47 lbs. / sq.ft
Electrical Requirements	One 120V, 20 amp GFCI dedicated circuit.	On/Off Control	Single button electronic control with twenty (20) minute timer
Material	Acrylic, fiberglass reinforced	Warranty	Limited Ten Year

