

117-3120 ALTO® 1.28



Round Front, SmartHeight™, Vitreous China, Two-Piece Toilet

FEATURES

- 3-bolt SmartFasten™ tank-to-bowl connection
- 1.28 gpf / 4.8 lpf high efficiency water consumption
- Uses 20% less water than conventional toilets
- Round front SmartHeight™ bowl
- 3-2" hybrid flapper flush valve
- Fluidmaster® anti-siphon pilot fill valve
- 12" rough-in
- Model 31 chrome-plated, plastic trip lever
- 2" glazed trapway
- The Mansfield® Limited Lifetime Warranty
- Available in White



MODEL 117-3120

Toilet seat not included





ROUND



SMARTHEIGHT ADA

COMPONENTS

MODEL #	DESCRIPTION	CODES/STANDARDS
117-3120	Round front, SmartHeight™ two-piece toilet.	  
117	Round front, SmartHeight™ toilet bowl only. Less toilet seat. Specify color.	
3120	Tank and cover only with left hand, front-mount, chrome-plated, plastic trip lever. Fluidmaster® anti-siphon pilot fill valve. Less supply.	
TANK TRIM & REPLACEMENT PARTS		
31	Trip lever - chrome-plated, plastic trip lever, left hand	
228	3-2" Hybrid flapper flush valve	
400A	Fluidmaster® anti-siphon pilot fill valve	
2206	Anti-siphon pilot fill valve (compatible replacement)	
630-0207	3" Replacement flapper kit	
160-LID	Tank lid	



When properly installed, this product meets the requirements for the Americans with Disabilities Act of 1990 (ADA).
Refer to local plumbing codes, as they may vary by location and application.

117-3120 ALTO® 1.28



Round Front, SmartHeight™, Vitreous China, Two-Piece Toilet

SPECIFICATIONS

MODEL #	DESCRIPTION	CODES/STANDARDS
117-3120	Round front SmartHeight™ (1.28 gpf / 4.8 lpf) two-piece toilet	  

MATERIAL	Vitreous China
WATER PRESSURE RANGE	20 to 80 PSI
FLUSH SYSTEM	3-2" Hybrid flapper flush valve
WATER USAGE	1.28 gpf / 4.8 lpf
WATER SURFACE AREA	8" X 9"
ROUGH-IN	12"
MaP RATING	800 grams

TRAP DIAMETER	2"
TRAP SEAL	2-7/8"
SHIPPING WEIGHT	Model 117 - 49 lbs. (22 kg) Model 3120 - 34 lbs. (15 kg)
WARRANTY	Vitreous China - Limited Lifetime Tank Trim - Limited One Year

TANK OPTIONS	
3173	Standard 1.28 gpf configuration: 3-2" hybrid flapper flush valve, Fluidmaster® anti-siphon pilot fill valve, left hand, color-match trip lever.
3173RH	Variation of model 3173, with right hand, color-match trip lever.
3165	Variation of model 3173, with cover lock.
3174	Variation of model 3173, with tank liner.
3120	Variation of model 3173, with left hand, chrome trip lever.
3125	Variation of model 3173, 14" rough-in.

TECHNICAL INFORMATION

Note: these dimensions are nominal and subject to change without notice.

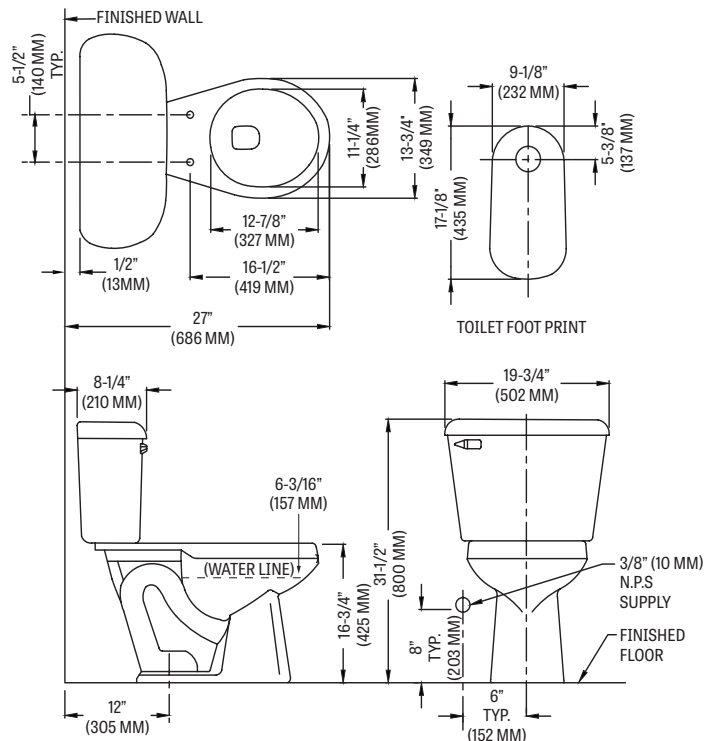

Fixture performance and specifications meet or exceed ASME A112.19.2/CSA B45.1 standards, and other state and local codes.